

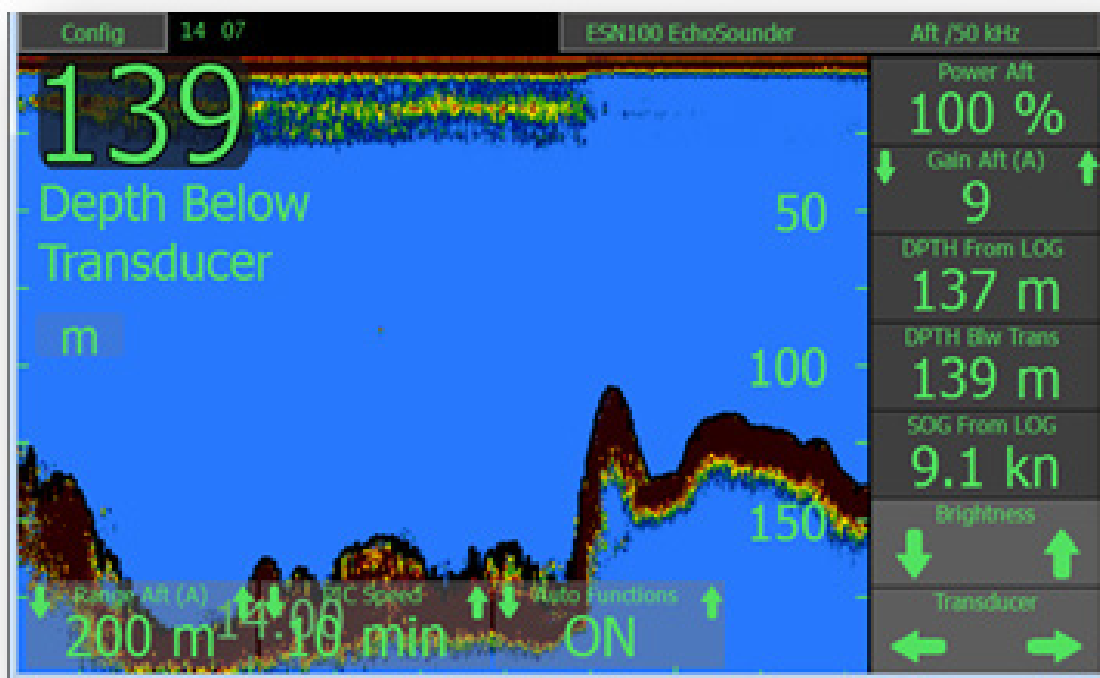

# ESN100

## Operation and Installation Manual

Single channel Dual frequency Echo sounder



## IMPORTANT

When doing service or repair, please wait two minutes after power off, before unplugging internal connectors.

Do not run the sounder for a long time with the transducer in air.  
The transducer may be damaged.

Weitergabe sowie vervielfältigung dieser unterlage, verwertung und mitteilung ihres inhaltes nicht gestattet, soweit nicht ausdrücklich zugestanden. Zuwiderhandlungen verpflichten zu schadenersatz.

Toute communication ou reproduction de ce document, toute exploitation ou communication de ou son contenu sont interdites, sauf autorisation expresse. Tout manquement à cette règle est illicite et expose son auteur au versement de dommages et intérêts.

Copying of this document, and giving it to others and the use or communication of contents thereof, are forbidden without express authority. Offenders are liable to the payment of damages.











Sin nuestra expresa autorización, queda terminantemente prohibida la reproducción total o parcial de este documento, así como su uso Indebido y/o su exhibición o comunicación a terceros. De los infractores Se exigirá el correspondiente resarcimiento de daños y perjuicios.

## Contents

---

<b>INTRODUCTION AND SPECIFICATION.....</b>	<b>6</b>
<b>INSTALLATION.....</b>	<b>7</b>
Transducer installation.....	8
Wiring.....	9
Communication cable ESN100-SB to JB50E1-SA.....	10
24VDC power.....	11
Alarm.....	12
PC connection.....	13
<b>SYSTEM SETUP.....</b>	<b>14</b>
Display description.....	14
SKIPPER Transducer setup.....	15
Other echosounder parameters (Main setup).....	17
NMEA In/Out Setup.....	18
Display setup.....	20
Dimming setup.....	21
Alert setup.....	22
<b>PC CONNECTION.....</b>	<b>31</b>
Printing Setup on PC.....	32
Printing Setup on ESN100.....	33
Download recorded data.....	34
Software upgrade.....	34
<b>ESN100 SCREEN FUNCTIONS.....</b>	<b>35</b>
Selectable Information.....	36
Auto Functions.....	36
Manual mode.....	36
Screen Configuration.....	37
Changing the look of the screen.....	42
Saved depth / History.....	44
<b>DIAGNOSTICS.....</b>	<b>46</b>
Transceiver unit JB50E1-SA Diagnostics.....	47
Diagnostics of the ESN100 using an ETT985.....	48
Display mounting option.....	49
<b>APPENDIX 1: INSTALLATION DRAWINGS.....</b>	<b>50</b>
Wiring diagram.....	50
ESN100-SB Display outline drawings.....	51
JB50E1-SA Transceiver unit outline drawings.....	52
ENS518-SA Transducer selector.....	53

**Table of abbreviations**

Symbol/abbrevia- tion	Explanation
TVG	Time variable gain
FWD	Forward position
AFT	Aft position
Pic Speed	Picture speed. The amount of time presented on the screen
DBT	Depth below transducer
DBS	Depth below surface
DBK	Depth below keel
Draft	Depth from water surface to the lowest point of the vessel
Offset	Distance from Transducer to the lowest point of the vessel
M	Meters
ft	Feet
ftm	Fathoms
m/s	Speed in meters / second
kHz	kilohertz (Frequency)
(A)	Automatic mode ( system self adjusts range and gain)
ALF	Alarm method according to IEC61924 / MSC 302 with category (CAT) A - Alarm to be acknowledged on the display only B - Alarm may be acknowledged remotely To work with ACN – Alarm Acknowledge, request, transfer, silence
ALR	Older alarm standard to work with ACK Acknowledge
 	Active Alarm/Warning unacknowledged alarm
 	Active Alarm/Warning acknowledged Alarm
 	Alarm/Warning rectified but unacknowledged
 	Alarm/Warning responsibility transferred
 	Alarm/Warning silenced for 30 seconds
S	Simulate mode
M	Mute Mode (see options section)

min	Minutes
V	Volts
DC	Direct Current (for voltage)
CAM	Central alarm management
INS	Integrated navigation system
LAN	Local area network
SFI	System function identifier, from standard IEC61192-450
UDP	Data sent on the LAN ports
MAC	Unique system identifier for LAN system
IP	Internet protocol address, unique in the network

## Introduction and Specification

The SKIPPER ESN100 is a navigational echo sounders. It is made to fulfill the ISO/IMO standards, as well as the modern IEC standards for maritime equipment and alarm handling.

Features include:

- Easy and logical operation via a touch display
- Flexible installation with minimal wiring
- Basic but comprehensive communication and features

The system has a single active channel, and can be used on both 50 or 200kHz transducers. The system is simple to install, and simple to use having automated functions such that the need for adjustment is minimal.

### Specification:

Function	Value
Frequency (selectable)	50kHz and 200kHz Two transducers can be connected at one time. Only one is operational at a time. Both transducers can be 50kHz and or 200kHz. If dual frequency 50/200kHz transducer, an automatical switching of frequency may be programmed (200kHz in shallow water 0-100m, 50kHz in deeper water >100m)
Electrical parameters CU-M001-SB Control Unit JB50E1-SA Transceiver unit	Nominal 24VDC ( Max 4W) 21VDC to 36VDC 24VDC (Max 8W) limits 21-36VDC
Connections ESN100-SB Control unit JB50E1-SA Transceiver unit	WAGO spring connector (12 pins) 1 port RJ45 (IEC61162-450) 1 x 2 pole connector 24VDC In( up to 1.5mm) 1 x 2 pole connector 24VDC Out to display( up to 1.5mm) 2x 3 pole connector for transducer (up to 1.5mm) 1x 2 pole connector for communication (up to 1.5mm) 1x 2 pole connector for power alarm (up to 1.5mm)
Acoustic output Power (Max)	600W
Outputs from control unit	1 x NMEA (IEC61162-1) DPT,PSKPDPT, DBS,DBK,DBT, ALR, ALF
Inputs to control unit	2 NMEA (IEC61162-1) Accepting signals from GPS, Gyro, Alarm, Draft, Dimming
Alarms	Follows IEC standards (ALF and ALR)
Functions	Auto Gain, TVG and Power Transducer positioning Internal sounder for alarm/button press
Depth logging	Basic 12 hours, External logging feature over network.
Transducer type, frequency, expected min/max depth range	ETN050, 50 kHz, 1m-450m ETN200, 200kHz, 1m-250m ETN200S, 200kHz, 1m-200m ETS50200, 50kHz and 200kHz, 1m -450m

## Installation

The ESN100 comprises of 2 units and up to 2 transducers

ESN100-SB Control unit: This display contains a single NMEA output, dual NMEA input and a communication pair to the transceiver. An additional RJ45 connector can be used for LAN communication.

JB50E1-SA Transceiver unit; This unit contains connections for 2 transducers (of either 50 or 200kHz) a connection for a single paired wire to the Control unit (Using RS485), and 24VDC power input. This unit can be mounted on the bridge, with long cables coming from the transducers, or near the transducer for lower noise.

The NMEA will typically be sent to a splitter to give the information to the bridge/alarm system and VDR.

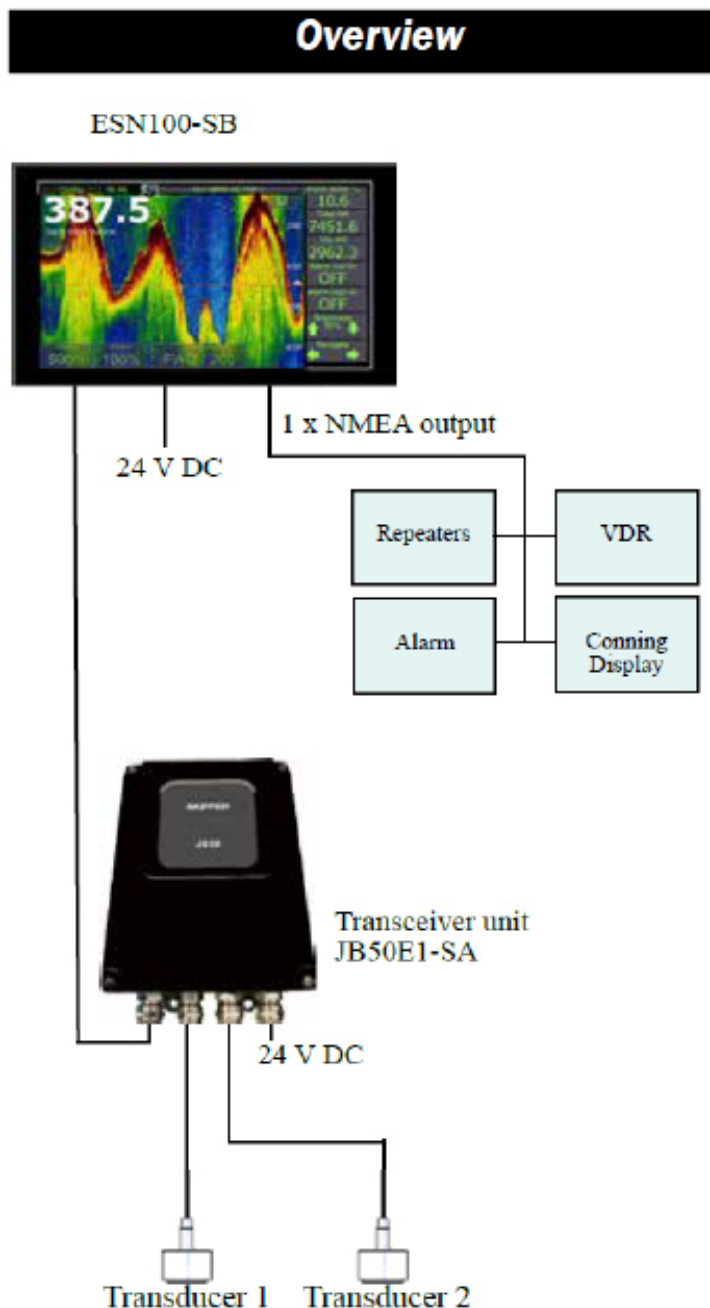

## Transducer installation

A transducer should be installed in an area securing optimal measurement free from noise and aeration. It should be possible to draw a cone of  $\pm 60$  degrees underneath the transducer without any objects entering the cone.

Generally there should be nothing in front of or close to the transducer that can cause turbulence.

Transducers are normally installed in the turbulence free area in the foreship as close to the bow as possible within the first 3<sup>rd</sup> of the ship. (see A on fig.)

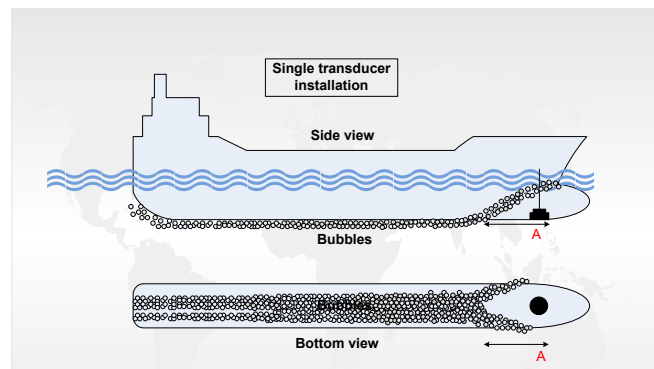

The transmitting surface of the transducer must be installed horizontally with no more than 5 degrees tilt. If this is not possible a blister should be assembled. This should have at least 0.3m of flat area around the transducer, and be tear drop shaped.

Do not mount transducers close to the propeller or aft of other hull installations (outlets, vents or other protruding details). It is necessary to select a part of the hull that is submerged under all load and speed conditions, and to avoid positions where air is trapped.

Refer to SKIPPER's installation procedures in the appendix and on our web site [www.skipper.no](http://www.skipper.no) regarding information about sea valve, tank installation, welding, cable glands etc.

### Note:

- Protect the active element of the transducer and **do not paint the surface**.

Transmission in **the air must be avoided!** This may cause mechanical damage of the element.

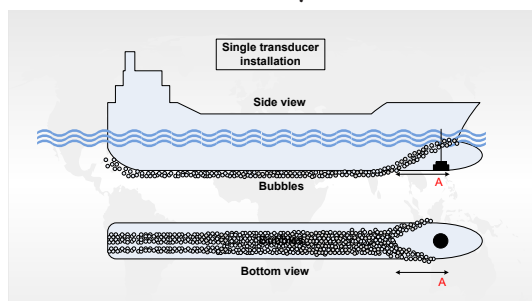

Larger vessels are often fitted with two transducers, one fore and one aft (see fig.)  
The fore transducer is the primary transducer, (normally 50 kHz).

The aft transducer is a secondary transducer, (normally 200 kHz).

The aft transducer may be troubled with aeration and noise and may not operate in speed  $>4-5$  knots.  
Aft transducer is mainly used to measure aft depth in slow speed and shallow water.



## Wiring

The transceiver unit may be positioned in any suitable dry area (IP56) between display unit and transducer. Normally this will be near the bridge area for easy supply of 24VDC supply.

If the transducer(s) are forward then there is an alternative to position the transducer in bow area closer to the transducer to avoid any electronic noise on the analogue signal between the transducer and transceiver.

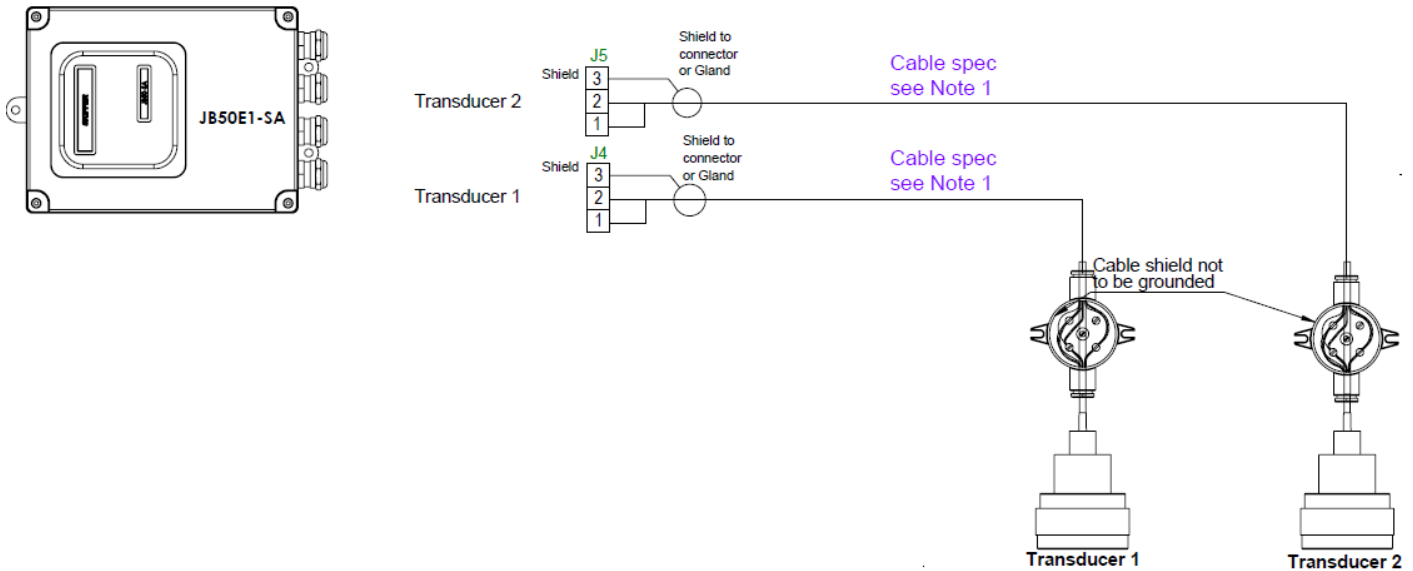

### Note 1

Length of cable	Cable Area
0-100	1,5mm <sup>2</sup>
100-300	2,5mm <sup>2</sup>
>300	JB50E1 unit to be mounted in Bow

Transducer cable type:  
1 x shielded pair (twisted pair recommended if available)

### Communication cable ESN100-SB to JB50E1-SA

The communication between Operator display unit ESN100-SB and Transceiver unit JB50E1-SA is a one pair cable, two way communication, RS485. See below drawing for specs.

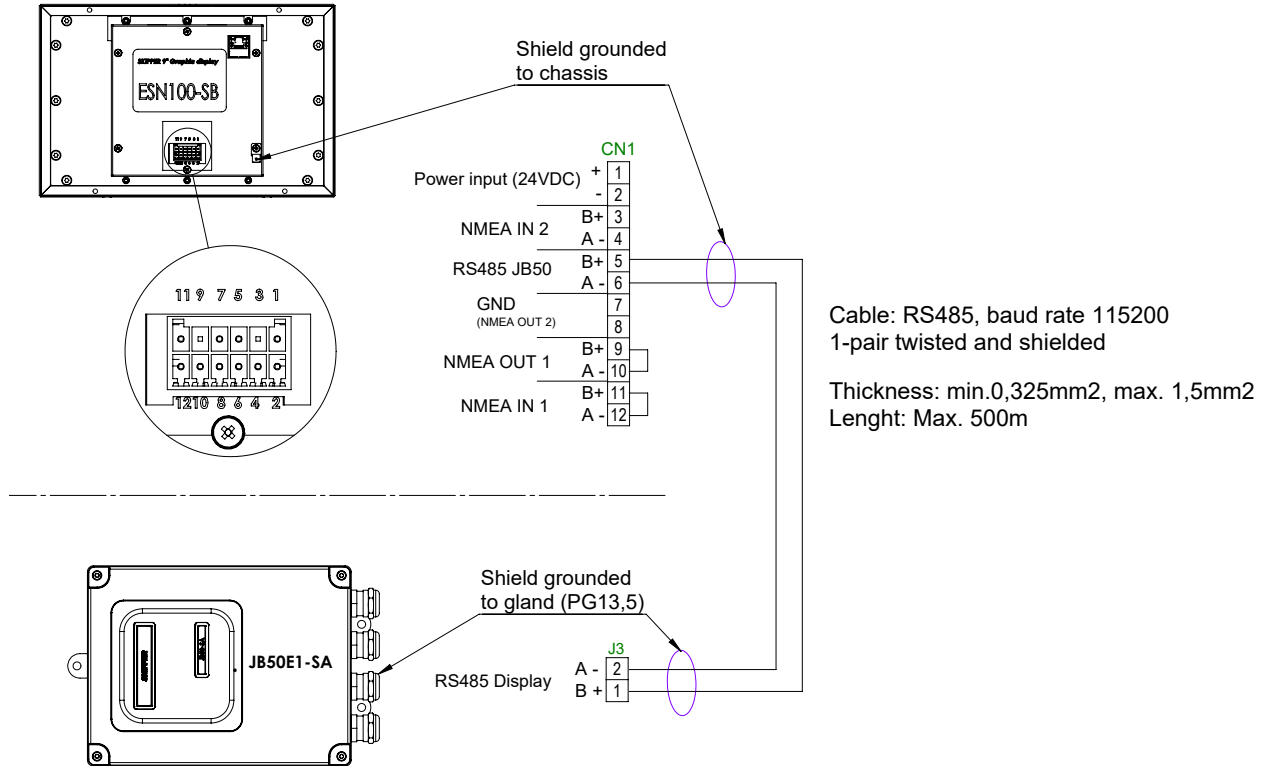

### Clamping the cables

Cables should be connected to WAGO connector, leaving approximately 3 cm of tail. They should be stripped with 6-7 mm of metal showing and these should be connected as in the diagram above. A small screwdriver with blade size approx 3.5 mm can be used. WAGO part no 210-719 is ideal for this use.

Outer shields should be collected and grounded in a ground stud on the edge of the cabinet. The outer insulation should be cable tied to the plastic handle of the connector, and securely anchored nearby. The plugs when re-fitted, must be installed such that their clips are fully in the up position.



## 24VDC power

Both ESN100-SB Display and Transceiver unit JB50E1-SA requires 24VDC power supply.

Alternative 1: Display powered from JB50E1-SA

In this configuration the system is switched on/off by the power switch inside JB50E1-SA unit.

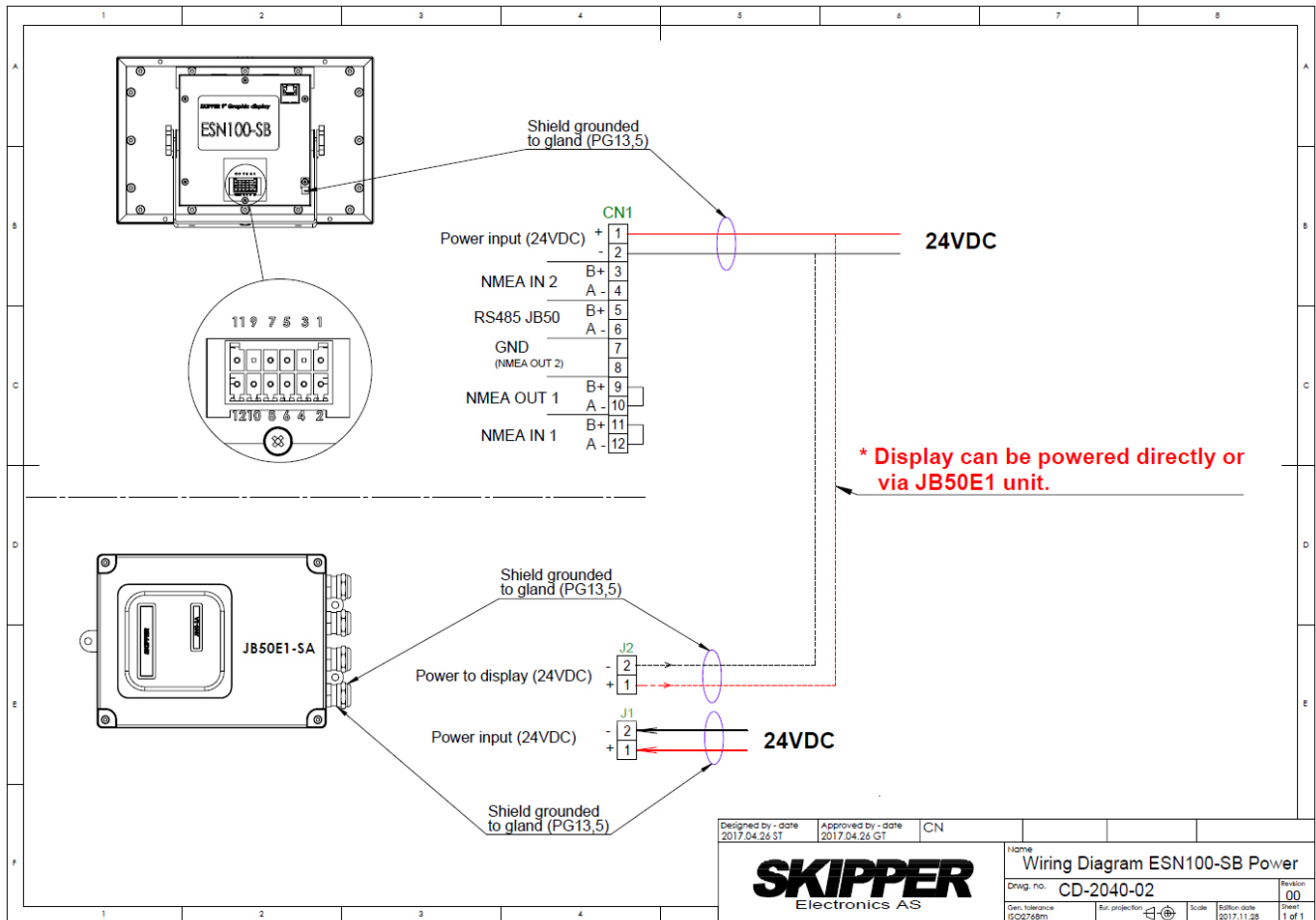

Power input circuitry inside JB50E1-SA with resettable fuse 2,5A (at 20deg C) power on/off switch and available 24VDC output to display unit.

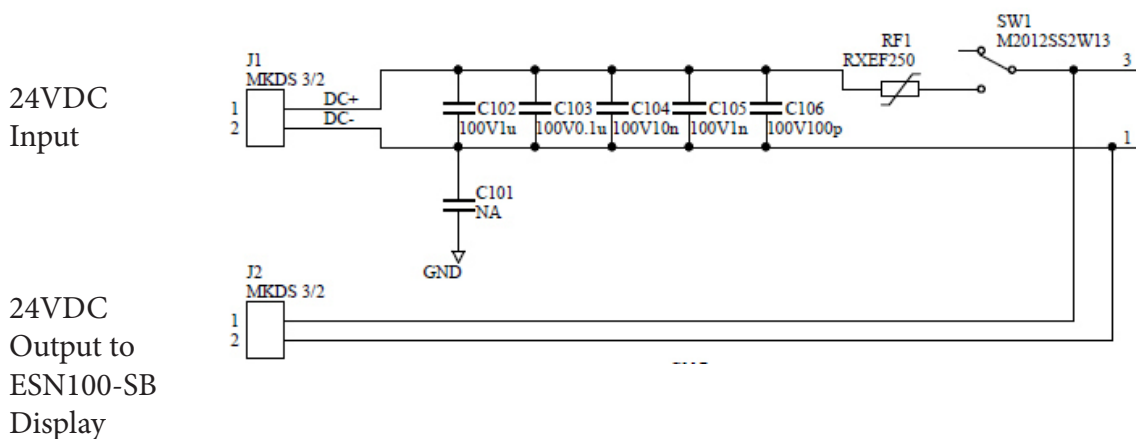

## Alarm

There are a number of alerts available. Shallow water alarm and power failure alert are mandatory. In addition there is a Deep water alert, power reduction, system error and time synchronisation alerts.

These are sent as alarm/alert sentences on the NMEA and LAN output of ESN100-SB unit.

The recommended setup of alarms from the navigational echo sounder is that echo sounder alarms are to be connected to CAM (Central Alarm Management). If the system fails, and there is no other system to detect the failure, a relay is available within the JB40POW unit that should be connected to an external beeper.

The ESN100 has two configurations of alarm NMEA formats available in the software setup.

ALF: Is the NMEA standard complying with IEC62923-1/2:2018 and IEC62288:2014.

ALR is the older standard and may comply with IEC61924-2:2012 and IEC62288:2014 only by connecting the "Power failure alarm relay" in JB50E1-SA to the external CAM. If no CAM is available, a beeper must be connected to the power failure relay in JB50E1-SA, and on "power failure" the beeper will sound.

More information about the alarm settings is available in the alarm setup part of this manual.

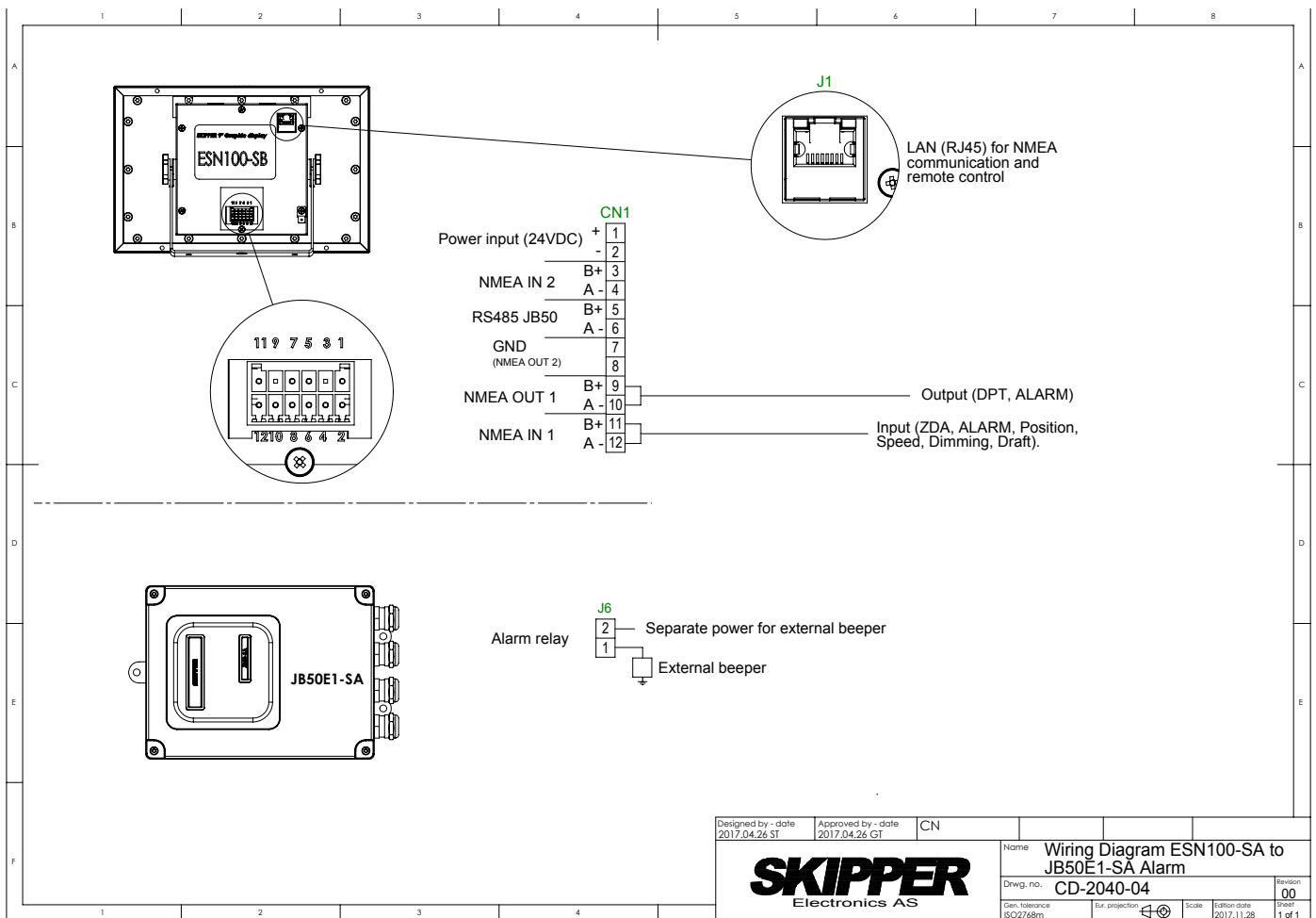

Designed by - date 2017.04.26 ST	Approved by - date 2017.04.26 GT	CN	Name Wiring Diagram ESN100-SA to JB50E1-SA Alarm	Revision 00
		Drwg. no. CD-2040-04	Scale	Sheet 1 of 1
		Gen. tolerance ISO2768m	Sur. projection 	Scale Edition date 2017.11.28

## PC connection

ESN100 can be connected via a LAN cable to a PC.

Features available via the ethernet LAN connector to a PC with SKIPPER software:

- Printing. Any printer can be used but the pages are formatted to A4 as standard.
- History download
- Software upgrade

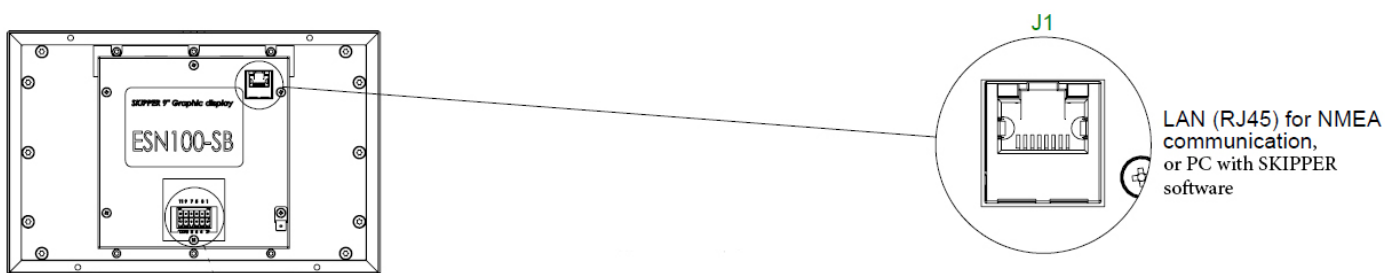

# System Setup

## Display description

The display is programmable and can be made to show what the user wishes. It comprises of 5 information's on the right, and 3 on the bottom. These information's can show parameters of the system, or parameters being sent into the system from other equipment. These parameters will, after a short time, slide off screen., Touching the screen will make them return.

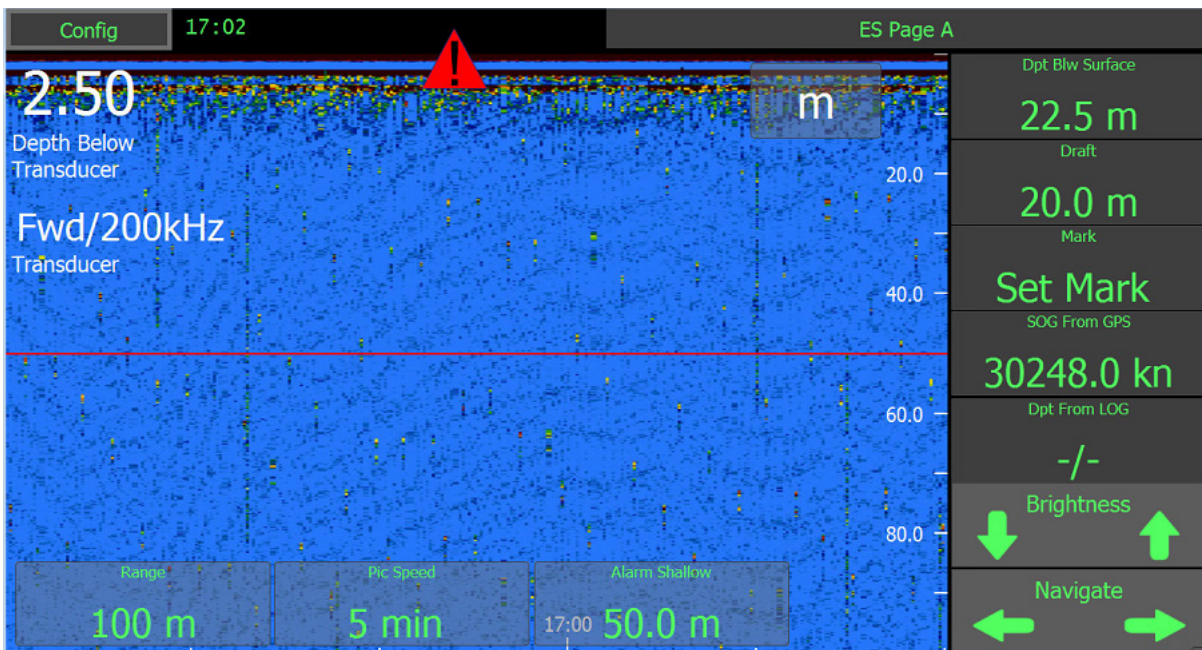

All these parameters are selected by default, but can be changed to show whatever the user chooses. See the User guide Runtime screen setup

Some parameters requires a password to enter. Password is "service"

Transducer settings and output settings are password protected for changes. The password for all units is 'service'. The password will be remembered for 1 hour, or until reboot of the system.

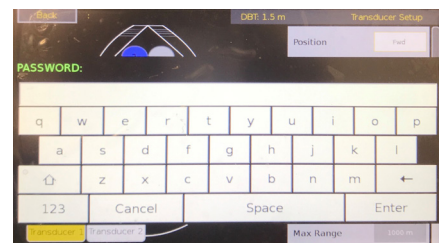

## SKIPPER Transducer setup

Once connected the system requires the installer to identify which transducer is connected to which of the 2 connectors. Both connectors can have a 50, 200 or combined 50/200 transducer fitted. To select the correct fixture, start the system and go to the config menus, and then the ES setup.

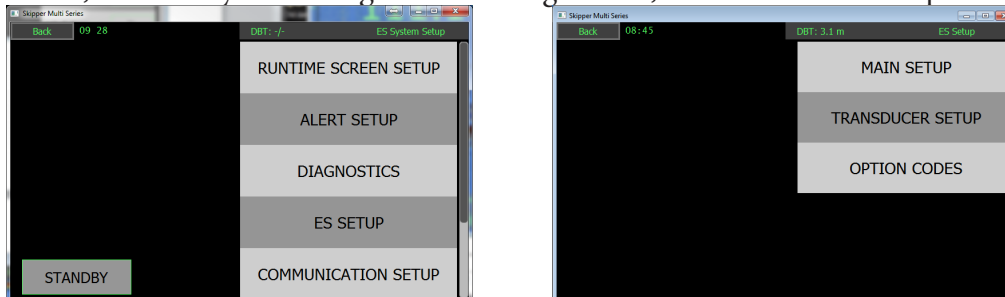

Here you can select the Transducer menu and by clicking on the transducer connector port you can move the transducer to the appropriate area of the vessel, and select the transducer, by part number. This will change the parameters to match your transducer.

If only one transducer is installed (to transducer 1) then “Transducer 2” must be set to position “Not connected”.

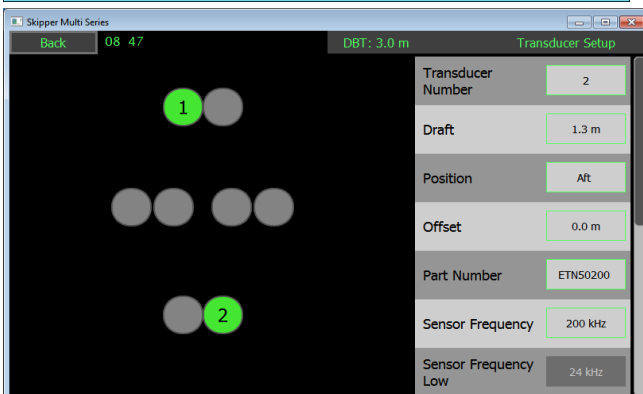
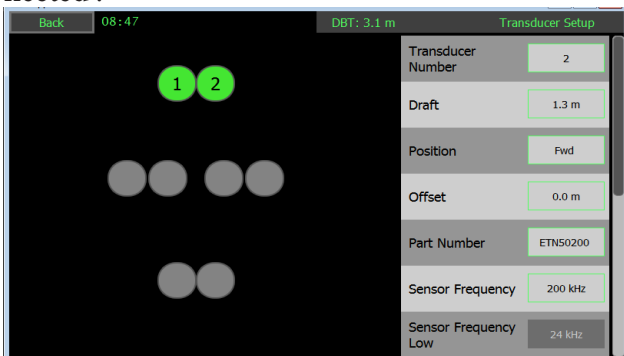

Selectable transducer types

Part number	Type	Approved for use
ETN050	50 kHz of types ETN50(X)G, ETN50(X)T	Yes
ETN200	200kHz of types ETN200(X)T	Yes
ETN200S	200kHz of type ETN200S(X)G, ETN200S(X)G	Yes
ETS50200	Combined 50 and 200kHz of types ETS50200(X)G and ETN50200(X)T	Yes
Other 50	Any other 50kHz*	No
Other 200kHz	Any other 200 kHz*	No

\*max power from system is 600W, in case of transducers other than SKIPPER approved they should be checked for max power.

Standard transducers have the required values set for “Max power” and “Max range”.

These can be changed in the settings of ‘Other’ See section ‘Other Transducers’

At least 1 installed transducer should be within the SKIPPER approved list.

**Non SKIPPER transducers setup**

If other transducers are selected then the following parameters may be changed

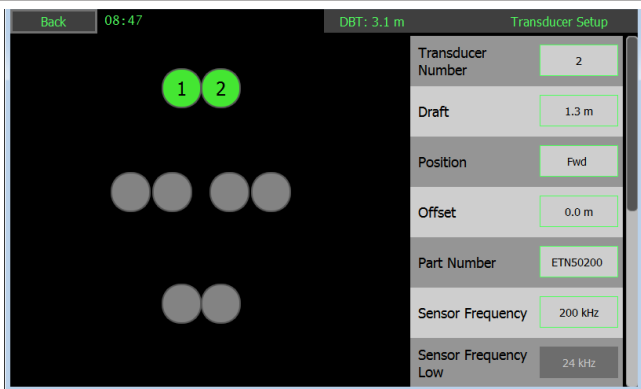
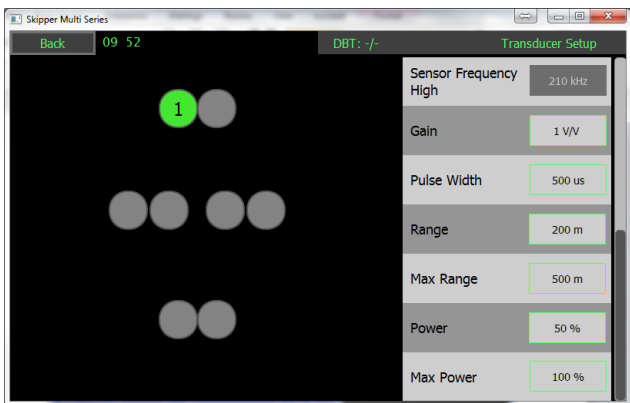
Screen	Function
	<p>Transducer connector number, Selected by pressing or touching the green position</p> <p>Draft of this sensor, can be changed on main screens</p> <p>Position (FWD,AFT,PORT,STRB,</p> <p>Offset. Distance from transducer to keel</p> <p>Part number, or Other 50 or Other 200</p> <p>Frequency 200 or 50kHz</p> <p>If 2 frequency transducer this is the low frequency</p>
	<p>If 2 frequency transducer this is the high frequency</p> <p>Min Pulse width at shallow water</p> <p>Maximum range of this transducer (limits the ESN100 to this range</p> <p>Maximum power for this transducer (100% is approx. 700W)</p>



## Other echosounder parameters (Main setup)

Other echosounder parameters are set by default, but can be adjusted in the ES menu if required. Some parameters and functions must be activated using a code number in the option codes tab. This is to prevent users inadvertently changing parameters that can make the system perform poorly.

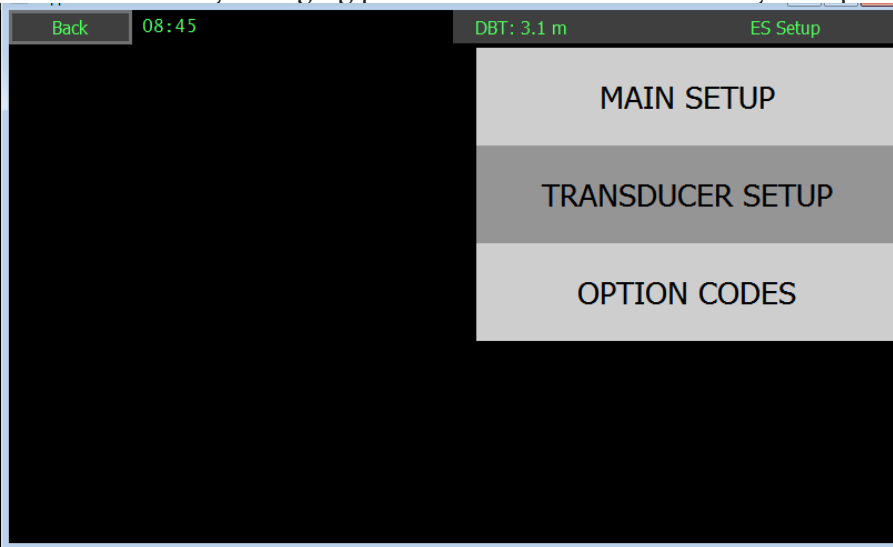

Screen Main setup	
	Auto functions will take control of range gain (and frequency)
	Change the design of the vessel in the menus
	Acoustics, ping method (not in use)
	Speed of sound can be changed with an option or with a temperature input
	User can define the sound speed with an option
	The depth scale (also available on screen)
Reset will reset the settings to default	

For options, see the options appendix

## NMEA In/Out Setup

The System has an internal RS485(isolated) communication to the transceiver.

To the outside world it has:

2 x NMEA (IEC61162-1) Inputs

1 x NMEA (IEC61162-1)output

1 x LAN (IEC61192-450) Port (In/Out)

This port can provide communication both by TCP/IP V4.0 or using IEC61162-450. If being used it requires a network that does not exceed 20Mbits/second. The system will exert/receive a maximum load of 40 data-grams/second

The communications menu allows the NMEA messages to be selected for the output

## NMEA Outputs

Default is DPT output and ALARM outputs set to the ALF version of the standard. NMEA style sentences will be shown as the 3 letter mnemonic when the sentence is sent or received.

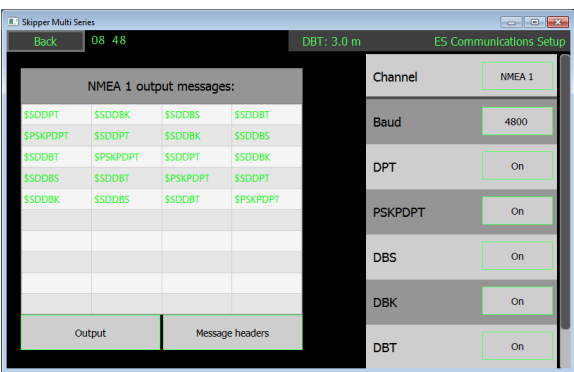
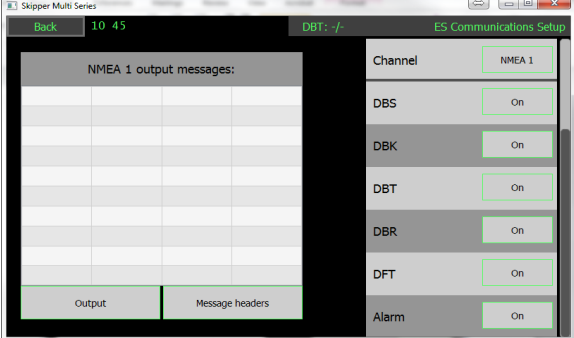
	<p>The selected channel (NMEA 1 or UDP)</p>
	<p>The Baud rate output (4800, 32400 or 115200)</p> <p>Output \$\$DPT (default ON) Depth below Transducer, offset to keel, Max range</p> <p>Output \$\$PSKPDPT (default ON) Depth below Transducer, offset to keel, Max range, position frequency ,text ,</p> <p>Output \$\$DDBS (default OFF), Depth below surface in feet, meters, fathoms</p> <p>Output \$\$SDBK (default OFF), Depth below keel in feet, meters, fathoms</p> <p>Output \$\$DDBT (default OFF), Depth below transducer in feet, meters, fathoms</p> <p>Alarm – The selected alarm type (ALF or ALR) will be sent via this port.</p>
<p>The left side show a terminal emulator that shows the input or output messages of the selected channel. Pressing ‘Message headers’ will show the full message.</p>	

Exact formats for these sentences can be found in the relevant IEC standards. PSKP sentences are proprietary for SKIPPER and has the following format.

\$PSKPDPT,x.x,x.x,x.x,xx,xx,c--c*hh<CR><LF>	
	Check sum
	Transducer location AFT, FWD, PORT, STB
	Echo sounder channel number
	Signal strength
	Maximum range scale in use, meters
	Offset to keel, meters
	Water depth relative to transducer, meters

Example \$PSKPDPT,3.7,0.0,500.0,,1,FWD\*11

### NMEA inputs

The ESN100 does not have any internal clock. Time from NMEA input is recommended to be installed:

Time. ZDA. Also accept GGA, GLL, RMC

All accepted NMEA inputs will be logged in history file

Format	Function
\$__DDC,X,yy,X,C*nn	Dimming function X= O,N,K,D , YY is % the system will accept X and adjust to the user set level (See dimming)
\$__ACK,xxx*nn	Acknowledge alarm ALR
\$--ACN,hhmmss.ss,aaa,x.x,x.x,c,a*hh	Acknowledge alarm ALF
\$HBT	Alert heartbeat
\$__XDR,D,x.x,M,pos,D,x.x,M,pos,D,x.x,M,pos,*nn	Draft sensor depth values. x.x - draft value pos - transducer position (fwd, aft, prt, str)
\$GPZDA,	Time and local time, The system will show UTC or Local time if available in the message
\$GPVTG	GPS Speed
\$GPGGA	GPS time and Position
\$GPGLL	GPS time and Position
\$--RMC	Time, Position and speed
\$--HDT	Heading true
\$--THS	True heading and status
\$--ROT	Rate of turn
\$--VBW	Speed through water (STW) and speed over ground (SOG). Longitudal+Transversal.
\$IIDPT	Depth from doppler speed log
\$--SRP	Identification

The Communications on NMEA are 4800, 8 data bits, 1 stop bit. Baud rate can be changed to 38400 or 115200

## Display setup

The Display setup menu gives access to the system parameters the dimming set up and the Network parameters.

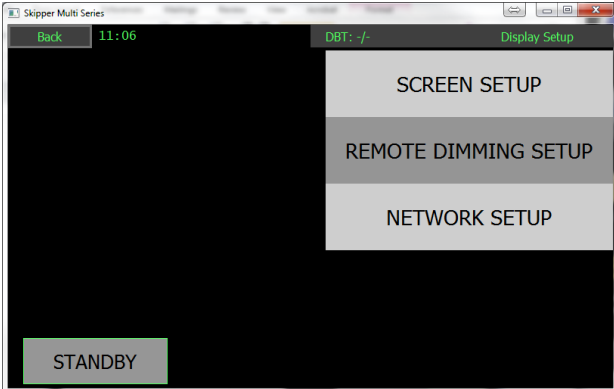

<p>General Screen setup</p>	
	<p>Only English currently available</p> <p>Button click, sound feedback on touching the screen</p> <p>Alarm sounder, on / Off (Fixed on in ALF mode)</p> <p>NMEA loop test. Self test on this screen</p> <p>Sounder test: This will beep at full volume</p>
<p>Software version can be updated via Service software</p> <p>Serial number of this product</p> <p>Hardware and firmware version and serial number of the JB50E1 transceiver unit</p>	

This screen sets up the hardware parameters of the control unit.

## Dimming setup

The Dimming levels can be set up on this screen. The user can select dimming and color choices for the 4 preset levels that can be sent remotely (using DDC NMEA command). When the user uses the on screen dimming, the color scheme will change when the dimming level passes the set % value.

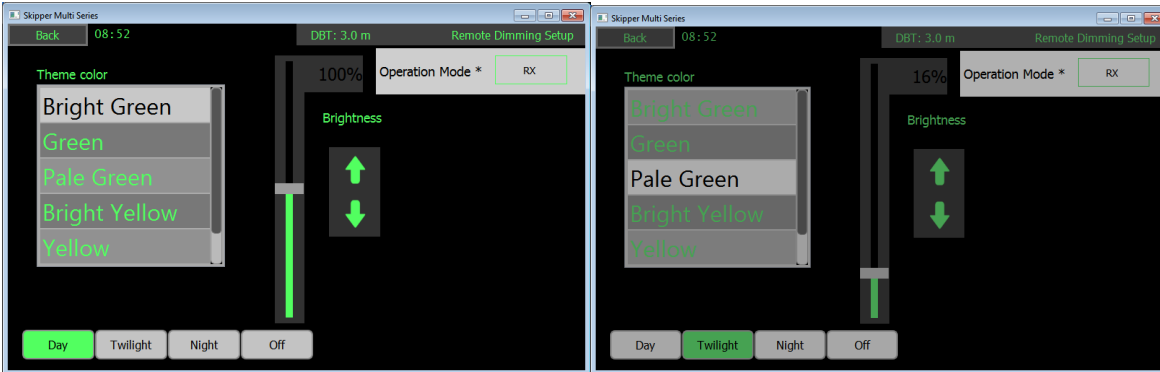

## Network setup

The system uses TCP/IP for upgrade, and as default is set to 172.16.1.108 & 109. Subnet mask is set to 255.255.255.0. The system allows use of private IP addresses including the recommended IP addresses according to the standard. If a non recommended IP address is entered, a pop up warning will show, and the colour of the IP address on screen will be orange. Only static addresses can be used.

The system uses the IEC61162-450 (2018) LWE communication standard. This uses a multicast methodology, where NMEA style messages are sent on one of a number of multicast addresses/ports, as specified in the standard. These are called transmission groups, and the natural group for the system is navigation 'NAVD'. Messages are sent using the datagram type UdpBc & RaUdp is used for echogram data. On startup a Identification message (SRP) is sent on the NETA group, dedicated for this as defined in the standard. This information will give the System Function Identifier (SFI), MAC address and the IP address.

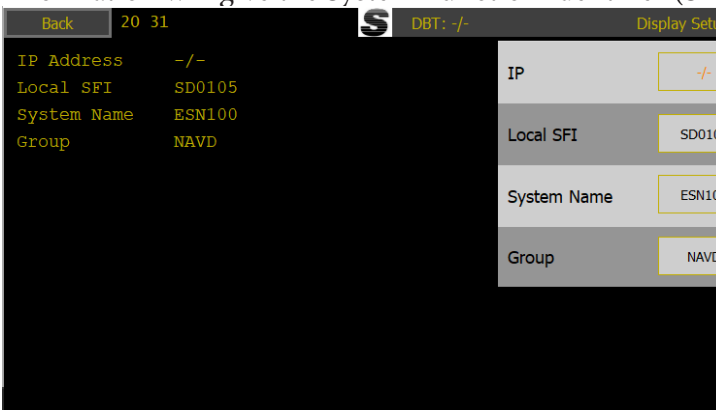



This standard requires a unique identifier for this equipment this is called the System Function Identifier (SFI). This is set by default to SD0108/9, but can and should be changed if more than one device on the network. The SFI is made up of 2 letters 'SD' as designated for an echosounder, and 4 digits from 0001 to 9999. This is used to allow the equipment to identify itself to other equipments, and to filter which messages are aimed for this device.

SFI, and IP address can also be adjusted using the SKIPPER service software. UDP messages can also be viewed from this software.

The messages sent can use the following tag blocks as defined in the standard: s;,d;,g;,x;,z;.:n:

## Alert setup

There are three levels of alerts:

Alarm		Shallow water	Most critical alert
Warning		Example: Power failure	Less critical alert
Caution		Example: Deep water	Least critical alert

Echosounder “Shallow water” alarm is a safety critical alarm and should be configured such that the user must view the echogram screen to acknowledge a shallow water alarm. This is so that the history of the water getting shallower is seen.

“Shallow water” is classed as a category A alarm. On a single channel ESN100 the shallow alarm will be triggered when the depth goes from deeper area, passes the alarm limit, on the active transducer.

If the system is part of an approved INS system with the capability of showing the echogram on other devices, then the system can be classed as Category B. This allows the Alarm to be acknowledged from that system. Responsibility transfer of this alarm will only be available in the CAT B mode.

The system has an internal alarm sounder, that can be disabled for CAT B usage on the display menu.



The ESN100 can be made to handle alerts using the ALR/ACK protocol or the ALF/ACN/ALC Protocol.

The Protocol is selected on the config – Alert setup page

The system is compliant with 2018 version of IEC62923.

The alerts setup page will allow the alerts to be setup by category, an alert ID number being assigned to the alert, according to the standard. These alerts can be disabled if required.

It is possible for multiple alerts to show, and these will be shown as symbol on the runtime screen, pressing these will give details and pressing '?' on the alert dropdown, will take the user to the diagnostic screen where there may be more information about the cause.

Alerts will be logged in the 24h history and can be seen in the table view or on the history screen using the mark feature.

The alerts will be sent out using the IEC61162-1/NMEA and IEC61162-450 LWE standard sentences. Aggregation is not in use for these sentences.

Responsibility transfer is available on all Category B warnings and alarms. This means the alert on Serial output will be present slightly before the alert shows on screen.

The system has a relay to indicate power failure in the JB50 transceiver unit. This will indicate failure in all or parts of the system. If the connected CAM / INS cannot detect lack of signal from the ESN100, This should be connected to a buzzer such that an audible signal is given in the case of power failure.

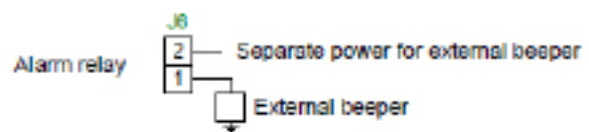

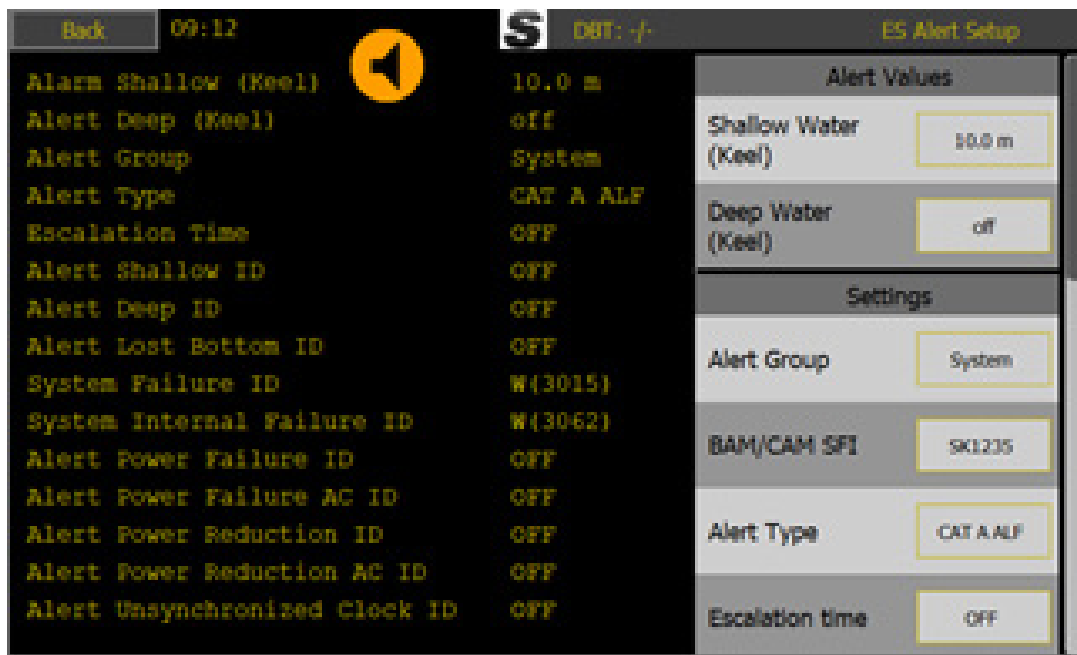

**User Defined Alert Values**

Alert	Range	Default
Shallow water (Keel)	1-99 m	10m
Deep Water (Keel)	2-5000m Can not be less than shallow water alarm	OFF

**Settings**

Setting	Selection	Default	Description
Alert group	DEFAULT, CAM1, CAM2, BAM1, BAM2	Default	The LWE group for alert messages to be sent on Default is the group set for the system in Screen setup - Networks
BAM/CAM SFI	XXYYYY (X is letter Y is number)	CA1235	The Identity of the centralised alarm system (normally CA or IN)
Alert type	ALF, ALR	ALF	The type of alert messages to be sent, ALF or ALR with or without acknowledge of shallow water
Escalation time	1m, 2,3,4,5 m	2 min	Warnings will be escalated after this time.



## Alarm sentences

The serial sentences follow the latest standards, ALF messages are, in some cases accompanied by a second ALF message with additional alert information.

```

SSDALF,2,2,6,,,,,0,3,7,4,NO DEPTH DETECTED*0C
SSDALC,01,01,53,1,,3119,8,1*6D
SSDALF,2,1,7,,A,A,V,,3031,1,1,0,SHALLOW WATER*14
SSDALF,2,2,7,,,,,3031,1,1,0,DEPTH BELOW KEEL < 0 M*0E
SSDALF,2,1,8,,B,W,V,,3032,2,1,0,DEEP WATER*58
SSDALF,2,2,8,,,,,3032,2,1,0,DEPTH BELOW KEEL > 0 M*03
SSDALF,2,1,9,,B,W,V,,3008,3,1,0,LOST BOTTOM*1B
SSDALF,2,2,9,,,,,3008,3,1,0,NO DEPTH DETECTED*3A
SSDALF,2,1,0,,B,W,V,,3015,4,1,0,SYSTEM ERROR*4F
SSDALF,2,2,0,,,,,3015,4,1,0,SENSOR COMMUNICATIONS*57
SSDALF,2,1,1,,B,W,V,,3062,5,1,0,INTERNAL ERROR*4D
SSDALF,2,2,1,,,,,3062,5,1,0,SETTING DISRUPTING SYSTEM*3C
SSDALF,2,1,2,,B,W,V,,3022,6,1,0,POWER FAIL DC*6C
SSDALF,2,2,2,,,,,3022,6,1,0,VOLTAGE TOO LOW < 12V*5D
SSDALF,1,1,3,,B,W,V,,3022,7,1,0,POWER REDUCTION 24V*63
SSDALF,2,1,4,,B,C,V,,3119,8,1,0,UNSYNC CLOCK*57
SSDALF,2,2,4,,,,,3119,8,1,0,NO EXTERNAL CLOCK INPUT*55
SSDALF,2,1,5,,A,A,U,,3031,1,2,0,SHALLOW WATER*16
SSDALF,2,2,5,,,,,3031,1,2,0,DEPTH BELOW KEEL < 0 M*0F
SSDALF,2,1,6,,B,W,U,,3032,2,2,0,DEEP WATER*56
SSDALF,2,2,6,,,,,3032,2,2,0,DEPTH BELOW KEEL > 0 M*0E
SSDALC,01,01,54,8,,3031,1,2,,3032,2,2,,3008,3,1,,3015,4,1,,3062,5,1,,3022,6,1,,3022,7,1,,3119,8,1*6A

```

```

UdPbc.lg:1-1-73,s:SD0105,d:CA1235,x:Nav.z:Nav,n:405*11$SSDALF,2,1,8,,A,A,V,,3031,1,1,0,SHALLOW WATER*1B
UdPbc.lg:1-1-74,s:SD0105,d:CA1235,x:Nav.z:Nav,n:406*15$SSDALF,2,2,8,,,,,3031,1,1,0,DEPTH BELOW KEEL < 0 M*01
UdPbc.lg:1-1-75,s:SD0105,d:CA1235,x:Nav.z:Nav,n:407*15$SSDALF,2,1,9,,B,W,V,,3032,2,1,0,DEEP WATER*59
UdPbc.lg:1-1-76,s:SD0105,d:CA1235,x:Nav.z:Nav,n:408*19$SSDALF,2,2,9,,,,,3032,2,1,0,DEPTH BELOW KEEL > 0 M*02
UdPbc.lg:1-1-77,s:SD0105,d:CA1235,x:Nav.z:Nav,n:409*19$SSDALF,2,1,0,,B,W,V,,3008,3,1,0,LOST BOTTOM*12
UdPbc.lg:1-1-78,s:SD0105,d:CA1235,x:Nav.z:Nav,n:410*1E$SSDALF,2,2,0,,,,,3008,3,1,0,NO DEPTH DETECTED*33
UdPbc.lg:1-1-79,s:SD0105,d:CA1235,x:Nav.z:Nav,n:411*1E$SSDALF,2,1,1,,B,W,V,,3015,4,1,0,SYSTEM ERROR*4E
UdPbc.lg:1-1-80,s:SD0105,d:CA1235,x:Nav.z:Nav,n:412*1B$SSDALF,2,2,1,,,,,3015,4,1,0,SENSOR COMMUNICATIONS*56
UdPbc.lg:1-1-81,s:SD0105,d:CA1235,x:Nav.z:Nav,n:413*1B$SSDALF,2,1,2,,B,W,V,,3062,5,1,0,INTERNAL ERROR*4E
UdPbc.lg:1-1-82,s:SD0105,d:CA1235,x:Nav.z:Nav,n:414*1F$SSDALF,2,2,2,,,,,3062,5,1,0,SETTING DISRUPTING SYSTEM*3F
UdPbc.lg:1-1-83,s:SD0105,d:CA1235,x:Nav.z:Nav,n:415*1F$SSDALF,2,1,3,,B,W,V,,3022,6,1,0,POWER FAIL DC*6D
UdPbc.lg:1-1-84,s:SD0105,d:CA1235,x:Nav.z:Nav,n:416*1B$SSDALF,2,2,3,,,,,3022,6,1,0,VOLTAGE TOO LOW < 12V*5C
UdPbc.lg:1-1-85,s:SD0105,d:CA1235,x:Nav.z:Nav,n:417*1B$SSDALF,1,1,4,,B,W,V,,3022,7,1,0,POWER REDUCTION 24V*64
UdPbc.lg:1-1-86,s:SD0105,d:CA1235,x:Nav.z:Nav,n:418*17$SSDALF,2,1,5,,B,C,V,,3119,8,1,0,UNSYNC CLOCK*56
UdPbc.lg:1-1-87,s:SD0105,d:CA1235,x:Nav.z:Nav,n:419*17$SSDALF,2,2,5,,,,,3119,8,1,0,NO EXTERNAL CLOCK INPUT*54
UdPbc.ls:CA1235,d:SD0105,n:034*60$ACHBT,10,A,6*06
UdPbc.lg:1-1-93,s:SD0105,d:CA1235,x:Nav.z:Nav,n:420*18$SSDALF,2,1,6,,A,A,U,,3031,1,2,0,SHALLOW WATER*15
UdPbc.lg:1-1-94,s:SD0105,d:CA1235,x:Nav.z:Nav,n:421*1E$SSDALF,2,2,6,,,,,3031,1,2,0,DEPTH BELOW KEEL < 0 M*0C
UdPbc.lg:1-1-96,s:SD0105,d:CA1235,x:Nav.z:Nav,n:422*1F$SSDALF,2,1,7,,B,W,U,,3032,2,2,0,DEEP WATER*57
UdPbc.lg:1-1-97,s:SD0105,d:CA1235,x:Nav.z:Nav,n:423*1F$SSDALF,2,2,7,,,,,3032,2,2,0,DEPTH BELOW KEEL > 0 M*0F
UdPbc.lg:1-1-99,s:SD0105,n:92*58$SDDPT,15,0,0,0,1000*4E
UdPbc.lg:1-1-1,s:SD0105,n:93*68$PSKPDPT,15,0,0,0,1000,0,,2,FWD*14
UdPbc.lg:1-3-2,s:SD0105,n:94*6E$SDBDK,49,2,f,15,0,M,8,2,F*18$rnlg:2-3-2,s:SD0105,n:95*6C$SDDBS,55,8,f,17,0,M,9,3,F*05$rnlg:3-3-2,s:SD0105,n:96*6E$SDDBT,49,2,f,15,0,M,8,2,F*07

```

### Alerts

All alerts are category B unless otherwise stated. Responsibility can be transferred on all alarms and warnings.

The system will only support 1 instance of each type of alert at a time.

Aggregation is not supported.

The system can be locally or remotely silenced for a period of 30 seconds. After this time the audible signal will return. New alerts that occur during the silenced time will sound even in this period.

Alerts	
Shallow Water	A(CATB,3031)
Deep	OFF
Lost Bottom	OFF
System Failure	OFF
System Internal Failure	OFF

Alert title	Alert message	Message Description	Alert types selectable	default	Alert ID ALF	Alert ID ALR	Remote Ack
Shallow water	SHALLOW WATER	DEPTH BELOW KEEL <xx M	<ul style="list-style-type: none"> <li>ALF CatA</li> <li>ALF CatB</li> </ul>	ALF CatA	3031	230	No Yes
Deep Water	DEEP WATER	DEPTH BELOW KEEL > XX M	<ul style="list-style-type: none"> <li>Caution</li> <li>Warning</li> <li>OFF</li> </ul>	Caution	3033 3032	457	No Yes
Lost bottom	LOST BOTTOM	NO DEPTH DETECTED	<ul style="list-style-type: none"> <li>Caution</li> <li>Warning</li> <li>OFF</li> </ul>	OFF	3009 3008	345	No Yes
System Error	SYSTEM ERROR	SENSOR COMMUNICATIONS or DISPLAY COMMUNICATIONS	<ul style="list-style-type: none"> <li>Caution</li> <li>Warning</li> <li>Warning W-A (Warning with escalation to alarm)</li> <li>OFF</li> </ul>	Warning	3016 3015 3015-3014	458 457	No Yes
System internal failure	INTERNAL ERROR	SETTING DISRUPTING SYSTEM	<ul style="list-style-type: none"> <li>Caution</li> <li>Warning</li> <li>OFF</li> </ul>	OFF	3063 3062	459	No Yes

Shallow water alarm : The Shallow water alarm is mandatory, but can be used in one of 2 methods

- CAT A ALF/ACN/ALC: The newer IEC62923 standard allowing the system. In this mode no remote status operations are available the system cannot be remotely acknowledged. Remote silencing is available
- CAT B ALF/ACN/ALC The system is connected to an approved INS, All remote functions are available

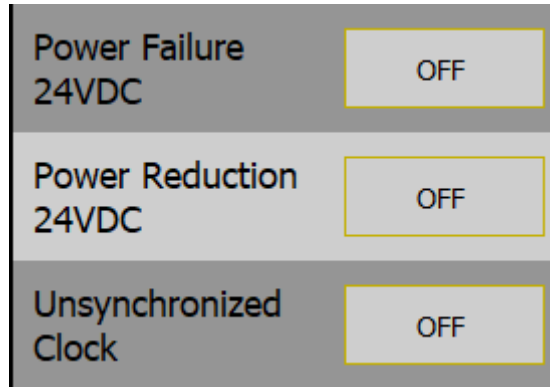

Alert title	Alert message	Message Description	Alert types selectable	default	Alert ID ALF	Alert ID ALR	Remote Ack
Power failure 24VDC	POWER FAIL	DISPLAY 24V <12V TRANS-CEIVER 24V < 12V VOLTAGE TOO LOW <12V	<ul style="list-style-type: none"> <li>Warning</li> <li>Off</li> </ul>	Off	3022	460	Yes
Power reduction 24VDC	POWER REDUCTION	DISPLAY 24V < 21V DISPLAY 24V >30V TRANS-CEIVER 24V <21V TRANS-CEIVER 24V >30V ALL 24V<21V ALL 24V>30V	<ul style="list-style-type: none"> <li>Warning</li> <li>Off</li> </ul>	Off	3022	460	Yes
Unsynchro-nised clock	UNSYNCH CLOCK	NO EXTER-NAL CLOCK INPUT	<ul style="list-style-type: none"> <li>Caution</li> <li>Off</li> </ul>	Off	3119	119	No

**Extra comments:**

A number of alerts will provide a second sentence with some diagnostic help, stating which part of the system has the error and what the probable cause is.

Internal errors are caused by the settings on the system

System failure means the system is not working to specification

**Escalation**

Escalation is the process of reminding the bridge staff that a warning has not been handled. The user can set a time that the system will wait before reminding. Escalation can either be sending a new message of the same status (warning) or can change the warning to an alarm, thereby demanding attention.

Alert Values	
Shallow Water (Keel)	10.0 m
Deep Water (Keel)	off
Settings	
Alert Group	System
BAM/CAM SFI	SK1235
Alert Type	ALF
Escalation time	2 min

Values and settings:

Shallow Water (keel)	The user set value at which the alarm sounds as the vessel approaches shallow water
Deep Water (keel)	a second warning/caution triggered if the vessel goes deeper than the specified value - Setting value to zero will deactivate them.
Settings	
Alert Group	The system will communicate with a CAM using a group. The default of this system is NAV, but this can be changed in the screen setup. The communication with the alarm management can also be via a second group such as CAM1 or BAM1. This can be selected here, and in that case the alarm messages will be sent to this group only.
BAM/CAM SFI	The Alarm management system will have a unique system function identity. This can be entered here. Communication with this is normally point to point, and other systems will not be able to send commands to this system
Alert type	This allows you to select the current alert method (ALF/ACNALC) or legacy (ALR/ACK) The ID's of the alerts will change to meet the demands of the standard
Escalation time	The amount of time a warning can remain unhandled, before resending, or changing to alarm status..

**Alert states**

The Following symbols indicate the current alert status

Symbol Alarm	Symbol warning	Symbol Caution	Alarm/Alert Status	Sound for Shallow water (Alarm)	Sound for other warnings
			Unrectified, unacknowledged	3 beep	2 beep
			Rectified, unacknowledged	No beep	No beep
			Unrectified, acknowledged	No beep	No beep
No symbol			Rectified, acknowledge (Normal)	No beep	No beep
			Silenced alarm	No beep for 30 seconds	No beep for 30 seconds
			Responsibility transferred	No beep	No beep
			Caution	No beep	No beep

If responsibility is transferred, the alert is being handled by another equipment, the system cannot be acknowledged locally (but can be acknowledged by the remote system). When the alarm is rectified, it will disappear from the system.

Examples

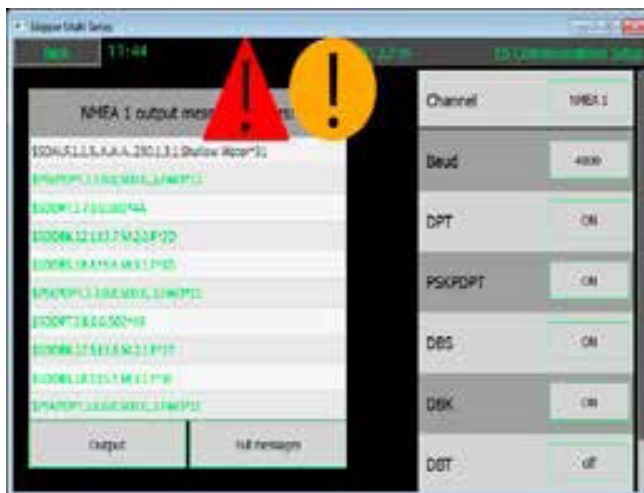

If connected to a central alarm management system, and this fails, the lack of an HBT NMEA message from the CAM will cause the system to take back control after a little more than a minute.

## Diagnostics of alerts

The Skipper service software contains a BAM simulator as part of the Communications /terminal emulator application allowing the user to test, acknowledge and transfer of responsibility, allowing the alerts and their statuses to be shown

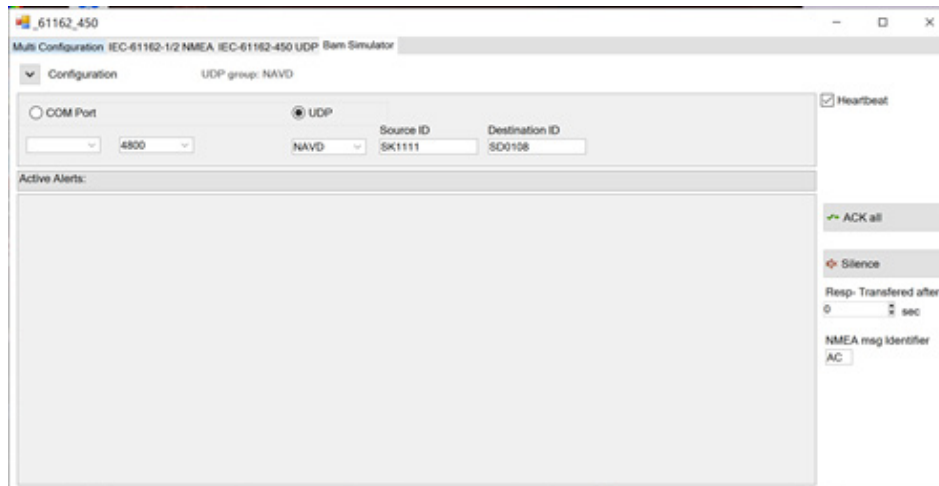

The following shows the NMEA output for an alarm test of all alarms/ warnings / cautions

```

SSDALF,2.2,6,,,,,0,3,7,4,NO DEPTH DETECTED*0C
SSDALC,01,01,53,1,,3119,8,1*6D
SSDALF,2,1,7,,A,A,V,,3031,1,1,0,SHALLOW WATER*14
SSDALF,2,2,7,,,,,3031,1,1,0,DEPTH BELOW KEEL < 0 M*0E
SSDALF,2,1,8,,B,W,V,,3032,2,1,0,DEEP WATER*58
SSDALF,2,2,8,,,,,3032,2,1,0,DEPTH BELOW KEEL > 0 M*03
SSDALF,2,1,9,,B,W,V,,3008,3,1,0,LOST BOTTOM*1B
SSDALF,2,2,9,,,,,3008,3,1,0,NO DEPTH DETECTED*3A
SSDALF,2,1,0,,B,W,V,,3015,4,1,0,SYSTEM ERROR*4F
SSDALF,2,2,0,,,,,3015,4,1,0,SENSOR COMMUNICATIONS*57
SSDALF,2,1,1,,B,W,V,,3062,5,1,0,INTERNAL ERROR*4D
SSDALF,2,2,1,,,,,3062,5,1,0,SETTING DISRUPTING SYSTEM*3C
SSDALF,2,1,2,,B,W,V,,3022,6,1,0,POWER FAIL DC*6C
SSDALF,2,2,2,,,,,3022,6,1,0,VOLTAGE TOO LOW < 12V*5D
SSDALF,1,1,3,,B,W,V,,3022,7,1,0,POWER REDUCTION 24V*63
SSDALF,2,1,4,,B,C,V,,3119,8,1,0,UNSYNC CLOCK*57
SSDALF,2,2,4,,,,,3119,8,1,0,NO EXTERNAL CLOCK INPUT*55
SSDALF,2,1,5,,A,A,U,,3031,1,2,0,SHALLOW WATER*16
SSDALF,2,2,5,,,,,3031,1,2,0,DEPTH BELOW KEEL < 0 M*0F
SSDALF,2,1,6,,B,W,U,,3032,2,2,0,DEEP WATER*56
SSDALF,2,2,6,,,,,3032,2,2,0,DEPTH BELOW KEEL > 0 M*0E
SSDALC,01,01,54,8,,3031,1,2,,3032,2,2,,3008,3,1,,3015,4,1,,3062,5,1,,3022,6,1,,3022,7,1,,3119,8,1*6A
    
```

## PC connection

Som features are only available via the ethernet LAN connector to a PC with SKIPPER software:

- Printing
- History download
- Software upgrade
- Diagnostics of alerts

The PC ethernet adaptor to be connected to the ESN100 needs to be preconfigured to be on the same subnet mask as the ESN100. e.g. 172.16.1.xxx (The ESN100 default IP address is 172.16.1.115.)

Setting up static IP address in Windows:

- 1: Click Start menu > Control panel > Network and sharing center or Network and internet > Network and sharing center.
- 2: Click change adaptor settings.
- 3: Right click on local area connection.
- 4: Click properties.
- 5: Select Internet protocol version 4 (TCP/IPv4)
- 6: Click properties.
- 7: Select Use the following IP address

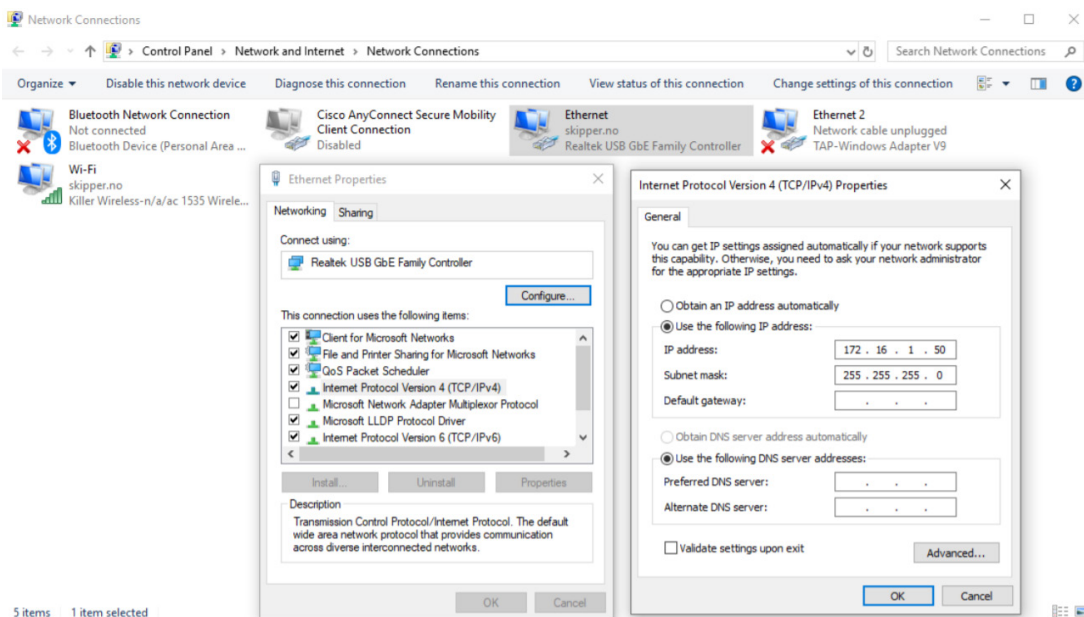

Install the the stand alone software “ESN printing.exe” or “SKIPPER service software”

### Printing Setup on PC

The printer will print a full page of information approximately every 15 minutes. The Printed page is in a .pdf format, and uses the local pdf driver of the PC. If the format is wrong, we recomend using the windows PDF or adobe acrobat drivers.

Both the PC connected to printer and the ESN100 has to be set up correctly to be able to print.

In SKIPPER service software

Select ESN100 > Select the printer tab.

(Software download available from [www.skipper.no](http://www.skipper.no))

Search for the ESN100 system to be connected to.

Click on the “Show print / Logfile” button.

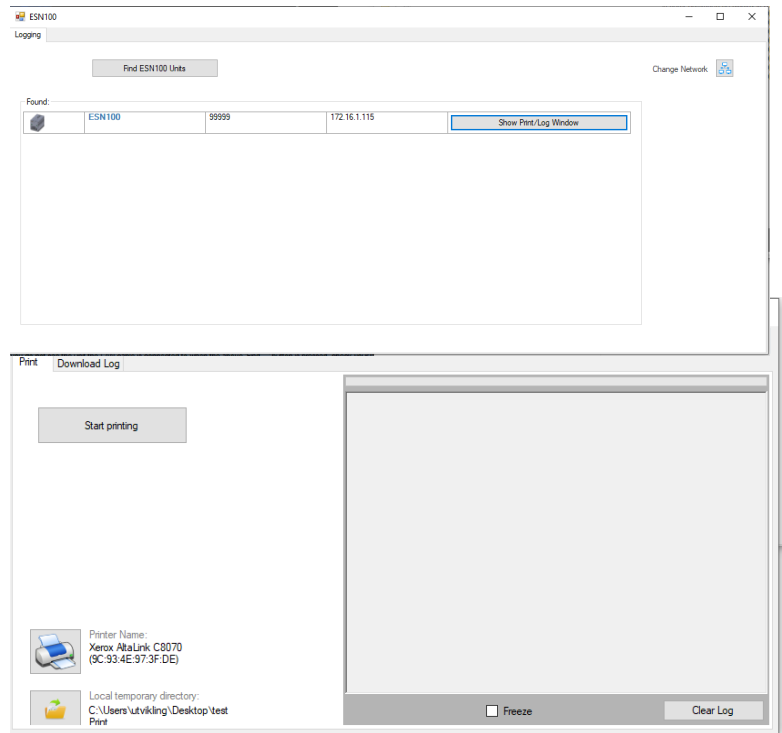

Select the printer to be used.

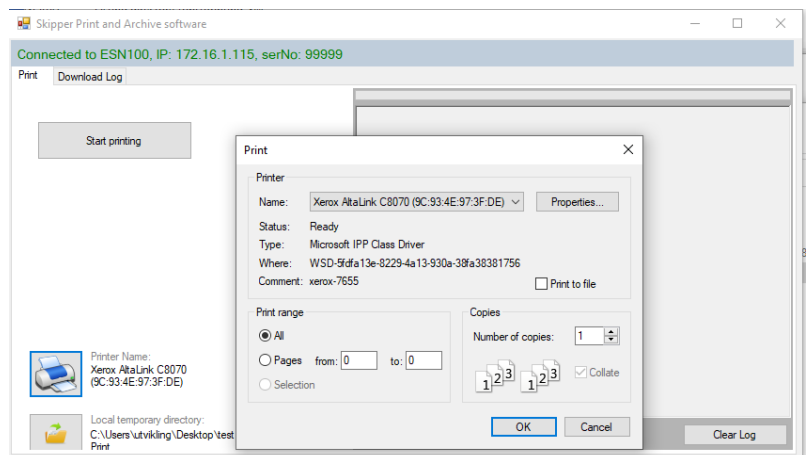

Select a temporary file if you do not wish to use the default.

Press “Start printing”.

Follow the connection and process details on the Log screen.



## Printing Setup on ESN100

On the ESN “Config” display, The menu ‘ Print setup’ gives you choice of what is to be printed.

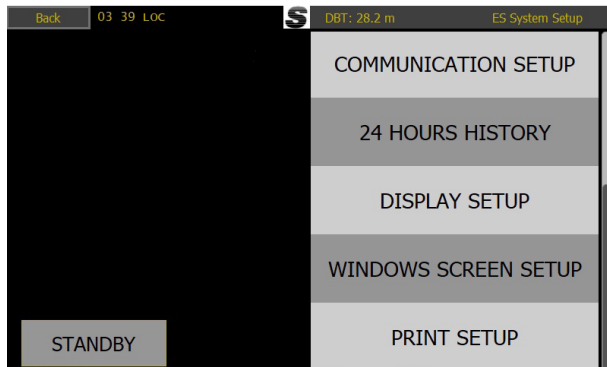

Echogram with relevant information, or/and a table of marks , giving time and depth when changes have been made to the system, or alarms have been triggered.



When the printer is first set to ON on the display, a Test/Title page will be printed. This can be used to test the setup is correct.

You can also turn on and off the printer on this screen, or by setting up one of the information areas as a printer on off button

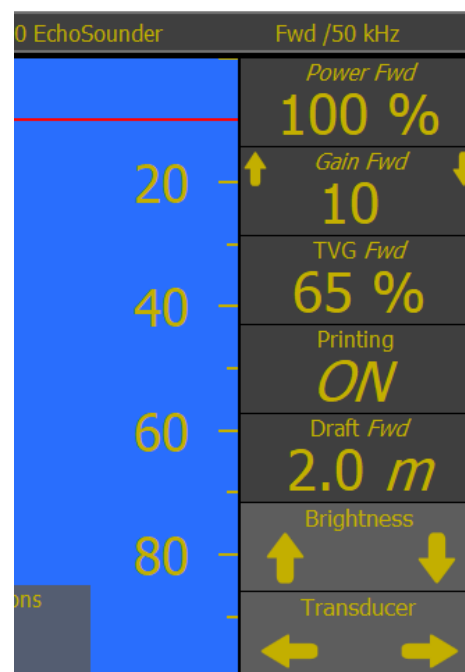
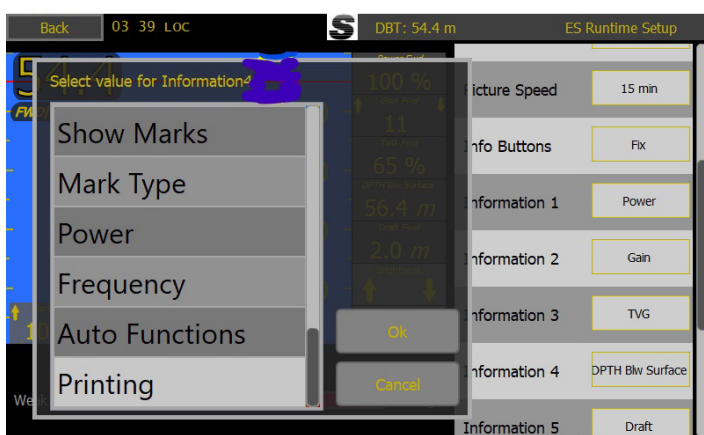

## Download recorded data

The internally recorded files can be downloaded for diagnostics using the tab ‘Download log’

Here the user sets the desired folder for the data to be downloaded to, and whether to delete the files on the display, giving more room.

Files available for download are:

- History files in PDF format. The PDF files are the same files as being printed. The system has about 2 days of files stored
- Raw data for diagnostics. May be sent to SKIPPER for evaluation. Latest 2 hours stored.

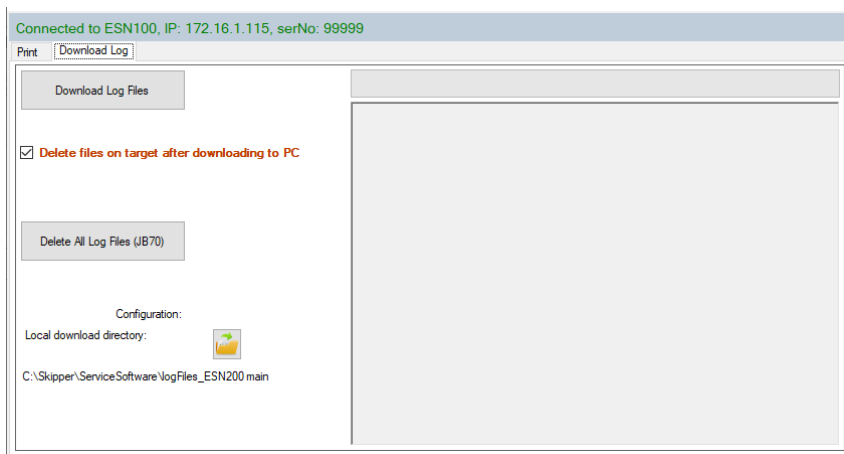

## Software upgrade

Software upgrade of ESN100-SB is performed in SKIPPER service software tool.

Latest ESN100- SB software is available as download from [www.skipper.no](http://www.skipper.no)

-Select “Echosounder” > “ESN100”



-Select “Echosounder” > “ESN100”

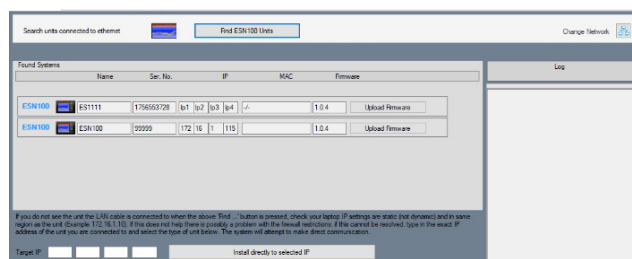

## ESN100 Screen functions

### Introduction

The ESN 100 Echosounder system is an echosounder with 1 channel that can be switched between frequencies and transducers in various locations of the vessel.

The Screen can be setup to show the parameters that the user wishes to see or control, but it also has an automatic function that takes over the control of range, gain, frequency and power of the system to minimize the required amount of user interaction.

The system has 1 mandatory alarm (Shallow water) and a second deep water alert. In addition it gives alerts of system failures.

The system will have 1 or 2 transducers installed, typically 50 kHz in the bow and 200kHz aft. With this system it is also possible to install a dual frequency 50 / 200kHz transducer both forward and aft, and the system can be made to select the best frequency at any particular time.

### Presentation

The user presentation screen is a single screen .

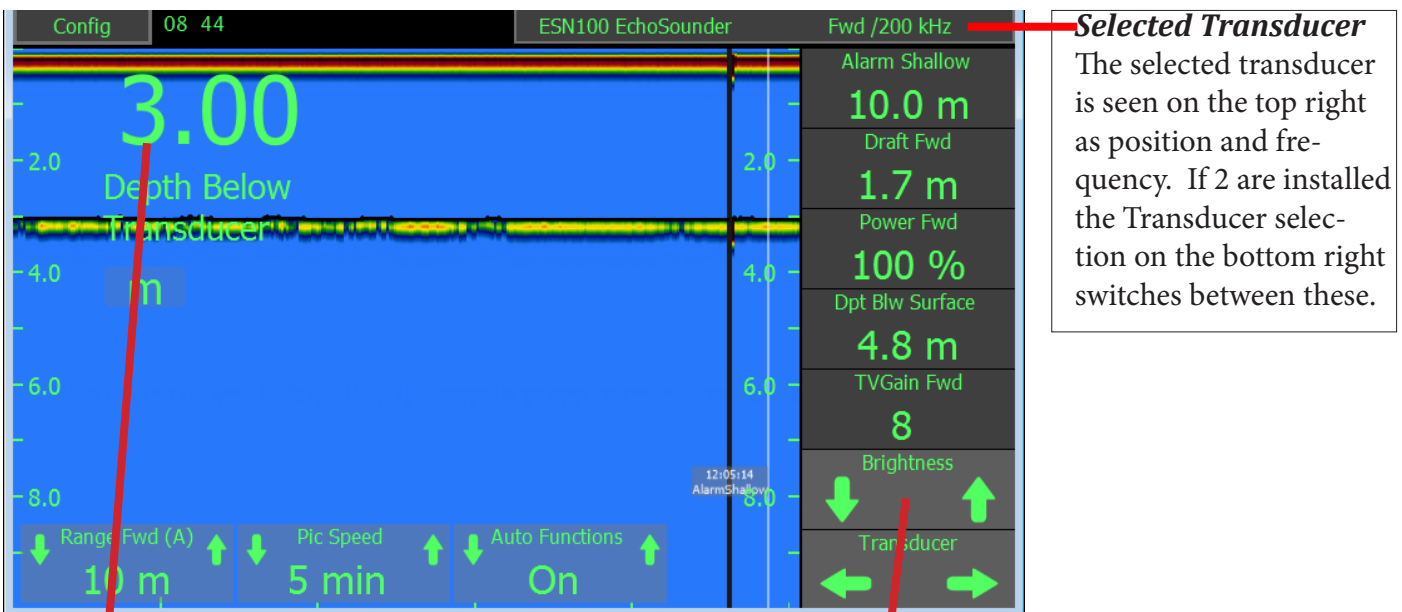

**Selected Transducer**  
The selected transducer is seen on the top right as position and frequency. If 2 are installed the Transducer selection on the bottom right switches between these.

**Depth and units**  
The Depth is shown numerically on the middle left, and the Echogram shows the variation of depth over time. The units can be changed by touching the unit sign, or in the menus

**Dimming level**  
The dimming can be controlled by touching the screen and adjusting the brightness parameter. Colour schemes will change as the dimming is adjusted, as set in the dimming menu. If the system is dimmed so deeply that the buttons cannot be seen, simply touch and hold the screen to lift the dimming level

### Selectable Information

All the buttons on the side and bottom can be selected. This information can be made to disappear after a short time. This can be recalled by touching the screen.

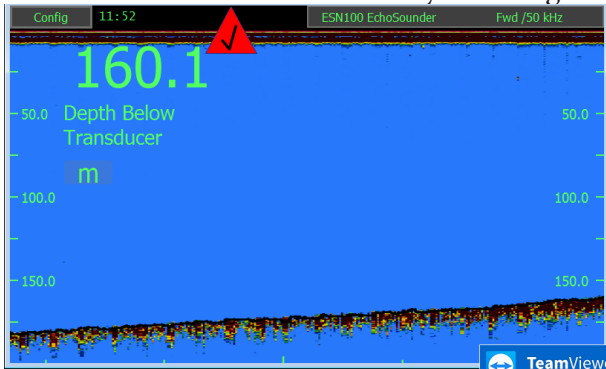

### Auto Functions

If the system is in Auto mode then the system will change the range and signal settings automatically, as the depth changes. If the user decides to take control of one of the auto parameters the system will inform that it is taken out of Auto mode and the user then has full control. The system can again be put into auto mode using on screen button (if selected), by pressing and holding a parameter, or within the menus.

### Manual mode

In Manual mode, the user will typically be required to control the Range, and gain of the system, although it is also possible to control the power and time variable gain (TVG) to give a clearer picture.

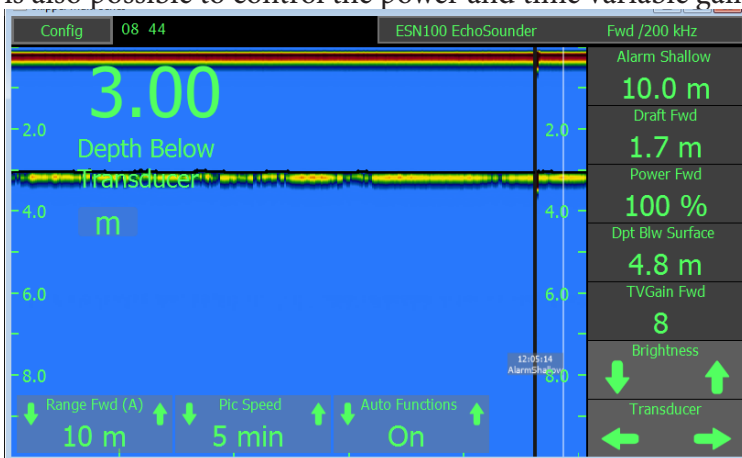

The system can be made to show the information/ options, or to hide it until the user touches the screen. (in Runtime screens)

## Screen Configuration



The main screen can be set up to show numerous informations on the right and below the screen  
Buttons on the information and bottom bar can be adjusted to show the information the user required in the runtime setup.





Press and hold the button to see all the choices.

Press on the config button and runtime setup to access the general screen information options

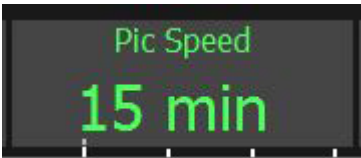
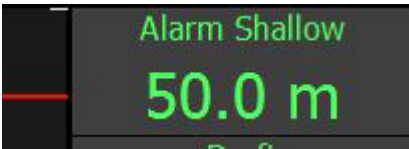
All button functions are available in the menus, so if a button is selected away, it can be accessed from the config menus.

Main adjustable features are:

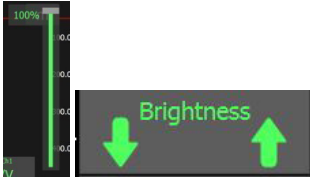
<p><b>Range</b></p> 	<p>Range is always available within a single press of the screen on the bottom left corner.</p> <p><b>Manual</b> Range can be set in 50m steps from 5m to the maximum the installed transducer can detect. Smaller steps are available below 50m.</p> <p><b>Auto:</b> In this mode the range will change based on the digital readout of the system. Auto range is part of the full range of auto functions and will cause other functions to become auto as well</p> <p><b>The value can be changed by pressing</b></p>
<p><b>Gain</b></p> 	<p>Gain is the amount the signal, reflected from the bottom, is amplified. This should be adjusted such that the signal strongly visible at the bottom and below, but not above the bottom.</p> <p><b>Manual :</b> Gain can be adjusted between 1 and 100% and is most effective for areas deeper than 50m</p> <p><b>Auto:</b> Auto gain will, combined with TVG and range adjust to give the most signal.</p> <p><i>If not on screen this is available in menu ES Setup</i></p> <p><b>The value can be changed by pressing and holding</b></p>
<p><b>TVG</b></p> 	<p>Time variable gain Predicts how much the sound will fades in the water , and compensates.</p> <p><b>Manual</b> adjusting this will give stronger/weaker signal near the surface, and can be used to reduce strong fish or bubble layers</p> <p><b>Auto :</b> This function works together with gain to provide an acceptable picture and continuous bottom detection.</p> <p><i>If not on screen this is available in menu ES Setup</i></p> <p><b>The value can be changed by pressing and holding</b></p>
<p><b>Pic speed</b></p> 	<p>Picture speed selects the speed at which the bottom will move across the screen. Units are the time to refresh the whole screen. A scale can be seen at the bottom of the screen.</p> <p><i>If not on screen this is available in menu Runtime setup</i></p> <p><b>The value can be changed by pressing and holding</b></p>
<p><b>Alarm shallow</b></p> 	<p>The Shallow water alarm is obligatory, and is indicated on screen by a red horizontal line. When the depth is shallower than this the alarm will sound. And an indication will show on the screen. Depending on the system configuration the system may require acknowledgement on the control unit, or may allow remote acknowledgement.</p> <p><i>If not on screen this is available in menu Alarms</i></p> <p><b>The value can be changed by pressing and holding</b></p>

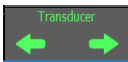
<p><b>Mark</b></p> 	<p>A vertical mark will be made on the screen when this option is active, when an important setting is changed, or an alarm/alert is sounded. This mark will also be stored in the saved depth logs. If GPS is connected the time and position will be recorded.</p> <p><i>If not on screen this is available in menu Runtime setup</i></p> <p><b>The value can be changed by pressing and holding</b></p>
<p><b>Picture colour</b></p> 	<p>The control unit is programmed with a number of colour schemes, some monochrome others heat colour based. These colour schemes can be selected, or in the dimming menu, made to change at different dimming settings.</p> <p><i>If not on screen this is available in menu Runtime setup</i></p> <p><b>The value can be changed by pressing and holding</b></p>
<p><b>Dimming</b></p> 	<p>Dimming up and down is available using the up and down arrows, or the slider that pops up when a dimming arrow is touched. IF the system is dimmed too far down, press and hold the screen, and it will return to a 'visible level'.</p> <p>The screen will not dim fully down if an alarm is active. If an alarm becomes active when fully dimmed, the screen will return to the 'visible level'. And return after acknowledgement</p> <p><i>This is always available, but can be adjusted in Display setup</i></p>
<p><b>Frequency</b></p> 	<p>If dual frequency transducers are installed then the frequency button will allow the user to change between the available frequencies.</p> <p><b>Manual:</b> 50kHz / 200kHz</p> <p><b>AUTO:</b> High frequencies test to have a greater resolution than low, so in this mode the system will change the frequency when the range is set to the shallower settings</p> <p>(A) Shows that the system is in auto mode for this parameter</p> <p>The position and frequency of the currently active transducer is displayed on the top banner. Touching this will change the frequency, if available</p> <p><i>If not on screen this is available in menu ES Setup</i></p> <p><b>The value can be changed by pressing and holding</b></p>
<p><b>Transducer</b></p> 	<p>The left right button will allow the user to change the transducer displayed. Each of these may have up to 2 frequencies.</p> <p><i>This is always available if installed. To install go to ES Setup</i></p>

Other information can be shown on the side parameter, these are from the NMEA inputs or from other systems connected via LAN. (e.g. DL2 speed sensor)

These include:

- Auto

Alert Deep	The value when a deep water alert or warning will sound
Draft	The distance from the surface to the lowest point of the keel
Depth below surface	The depth value from surface to the bottom
Depth below keel	The depth value from the lowest point of the hull
Depth below transducer	The depth value to the bottom from the face of the transducer
Speed from GPS	Speed over ground from a connected GPS
Speed from LOG	Speed over ground from a connected log
STW from log	The Speed through water from a connected log
Rate of turn	The Rate of turn from a connected gyro
Depth from Log	The depth measured by the log sensor

All adjustments are available from the menus by pressing **Config**

Depending on which transducers are connected, the user can switch between transducers or frequency using the **navigate arrows**. The current transducer frequency and position is shown in the **text under the depth**.



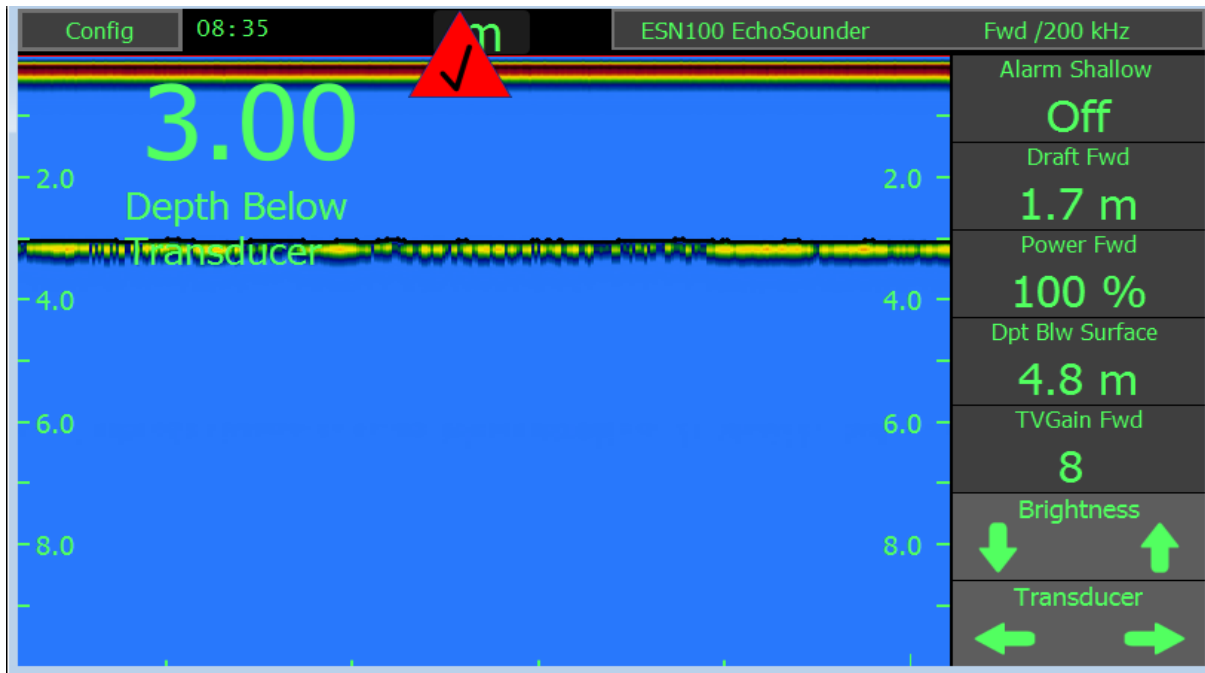

To change a value on one of the information bars, a short press on the information will move to the next natural value. A long (3 second) press will show a menu of the available options. RANGE is always available in the bottom left position with a single touch.

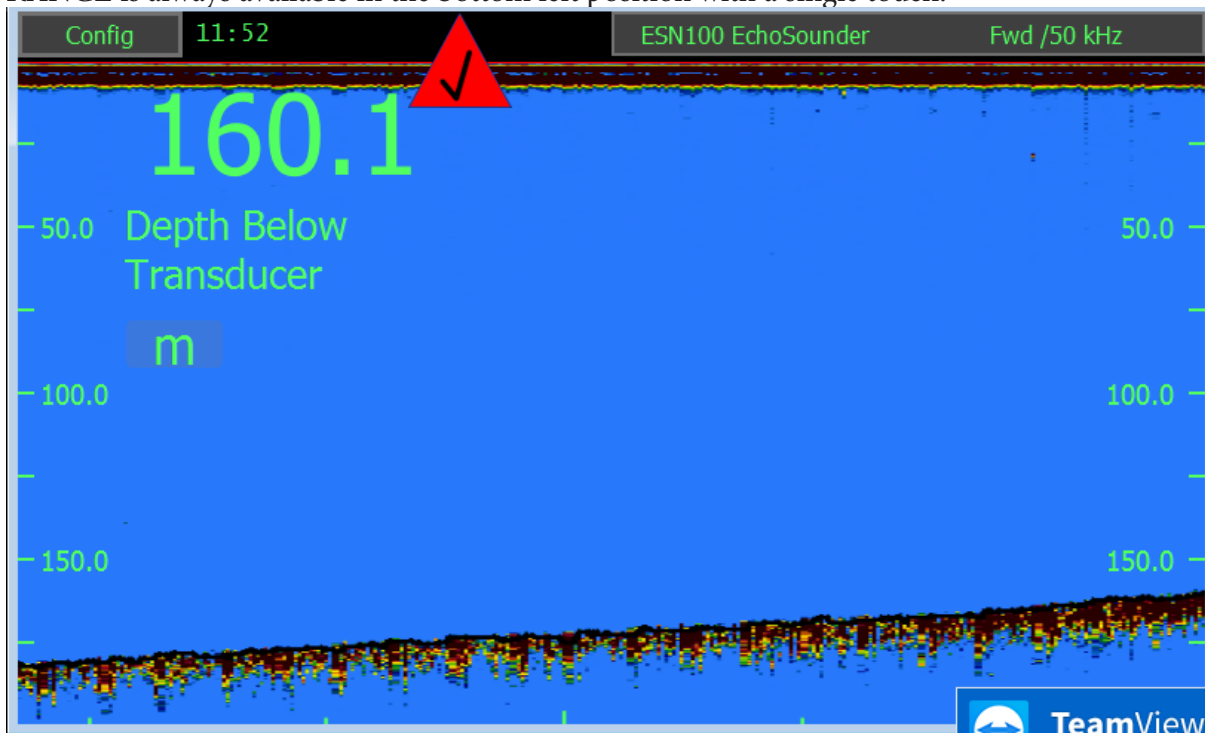

After 5 seconds the informations will slide of the screen. They can be made stay fixed in the RUNTIME menu.

Normal operation, the red line shows where the alarm/alert level is.

## Changing the look of the screen

Go to Runtime Menu by pressing config in the top left. In this menu you will see the available Pages, and these can be individually tailored to show the information the user wishes.

The Colour scheme is seen under the display picture.

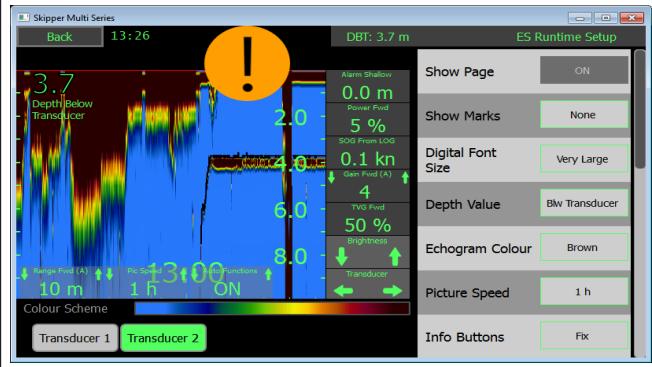
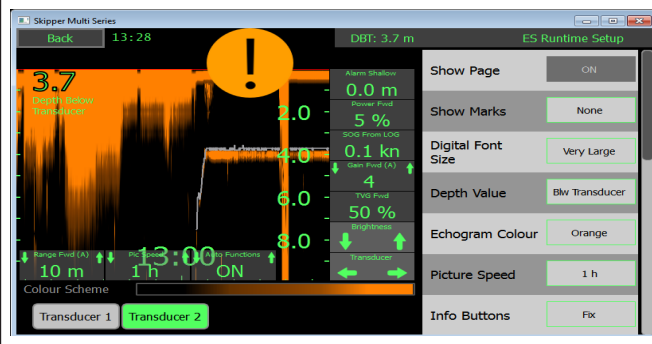
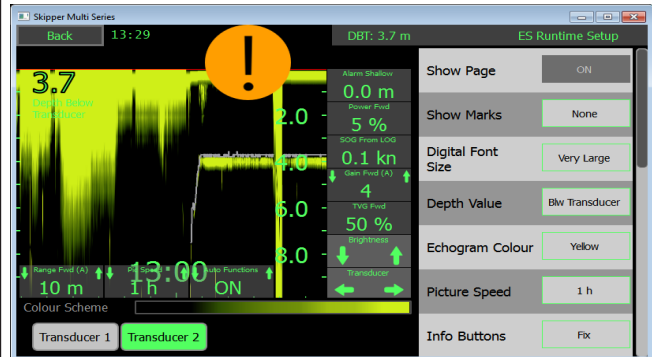
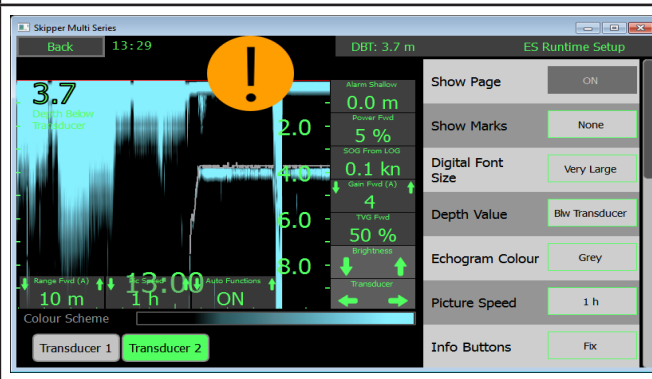
 <p>The screenshot shows the 'ES Runtime Setup' menu. The 'Echogram Colour' option is set to 'Brown'. The background echogram is displayed in shades of brown. A large orange exclamation mark is overlaid on the top center of the screen.</p>	<p>Brown</p>
 <p>The screenshot shows the 'ES Runtime Setup' menu. The 'Echogram Colour' option is set to 'Orange'. The background echogram is displayed in shades of orange. A large orange exclamation mark is overlaid on the top center of the screen.</p>	<p>Orange</p>
 <p>The screenshot shows the 'ES Runtime Setup' menu. The 'Echogram Colour' option is set to 'Yellow'. The background echogram is displayed in shades of yellow. A large orange exclamation mark is overlaid on the top center of the screen.</p>	<p>Yellow</p>
 <p>The screenshot shows the 'ES Runtime Setup' menu. The 'Echogram Colour' option is set to 'Grey'. The background echogram is displayed in shades of grey. A large orange exclamation mark is overlaid on the top center of the screen.</p>	<p>Grey</p>

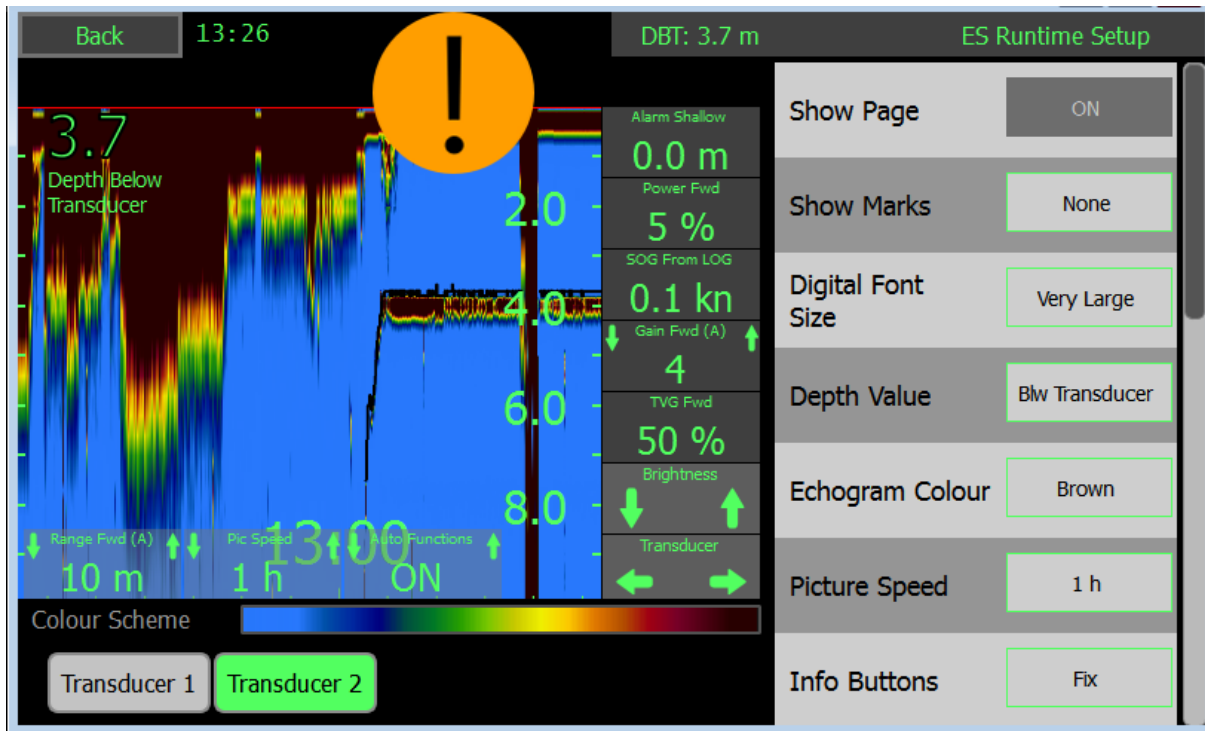

Button	Description
Page A (lo/hi)	The Transducer connected to transducer connector 1 (if this is a dual frequency transducer it will show the low or high frequency)
Page B (lo/hi)	The Transducer connected to transducer connector 2 (if this is a dual frequency transducer it will show the low or high frequency)
Digital Font size	Adjusts the size of the depth text on the left. Small – 1m viewing distance Medium – 3m viewing distance Large – 5m viewing distance
Depth value	The reference point from which the depth is measured (Surface/Transducer/Keel)
Info buttons	The information on the right can be made fixed or to disappear after a time
Information 1-5	Select the information/parameters to be shown on each information.
Bottom bars	The information on the bottom can be made fixed or to disappear after a time
Bottom bar 1-3	Select the parameter/ information to be shown on the bottom bar. (1 is fixed to range)

### Saved depth / History

The ESN100 is saving depth information for 24 hours, data recorded every 1 minute. This data can be shown on a single screen and is available in the HISTORY Menu

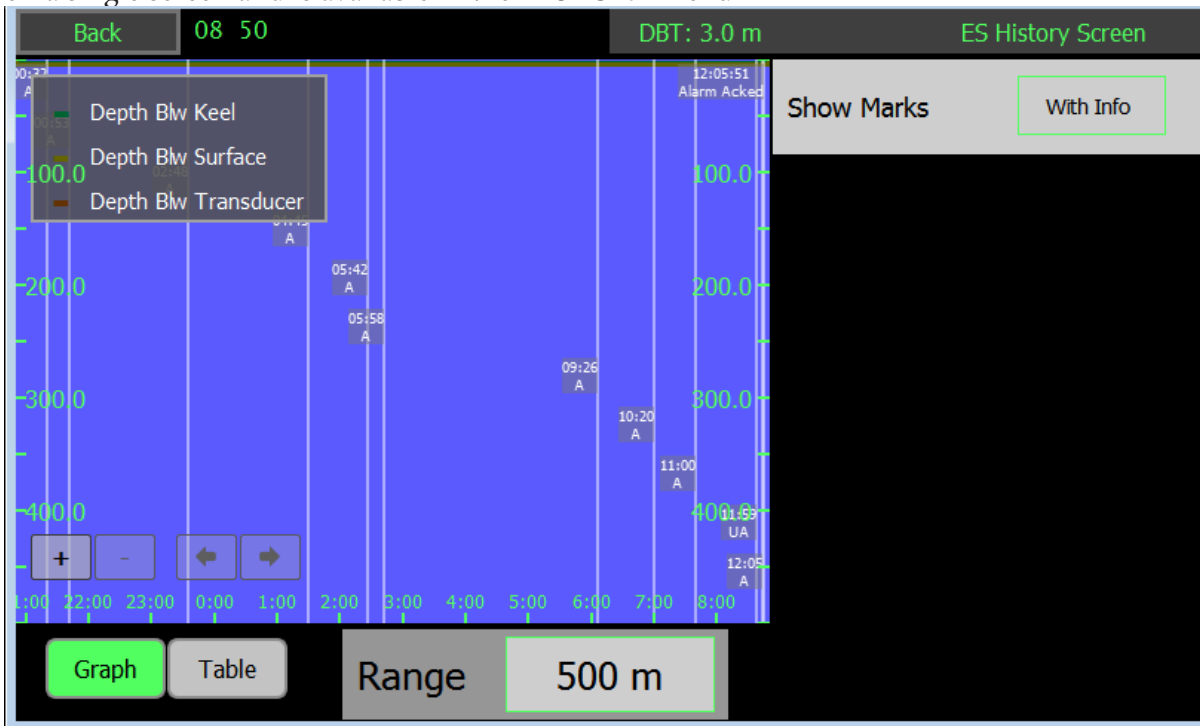

By selecting table, the depth of at least every minute and marks in between (indicating changes or highlighted events such as alarms or auto changes) are listed with time and position, if available.

Back 08 50 DBT: 3.0 m ES History Screen

Time	Depth	Message
00:11:23	3.09 m	-
00:12:24	3.1 m	-
00:13:24	3.09 m	-
00:14:24	3.13 m	-
00:15:24	3.09 m	-
00:16:24	3.1 m	-
00:17:24	3.09 m	-
00:18:24	3.09 m	-
00:19:24	3.08 m	-
00:20:24	3.09 m	-
00:21:24	3.09 m	-
00:22:24	3.09 m	-
00:23:24	3.1 m	-
00:24:24	3.09 m	-
00:25:24	3.09 m	-
00:26:24	3.09 m	-
00:27:24	3.09 m	-

Show Marks With Info

Graph Table

By changing the range you can see more detail of the echogram

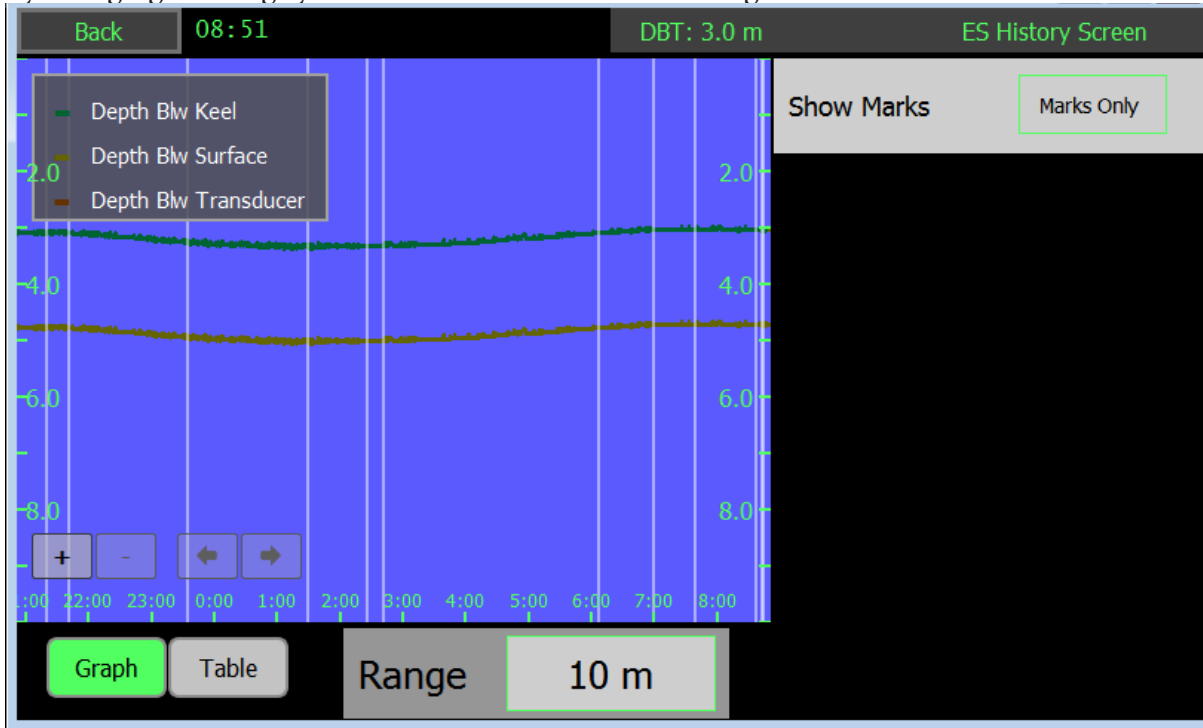

## Diagnostics

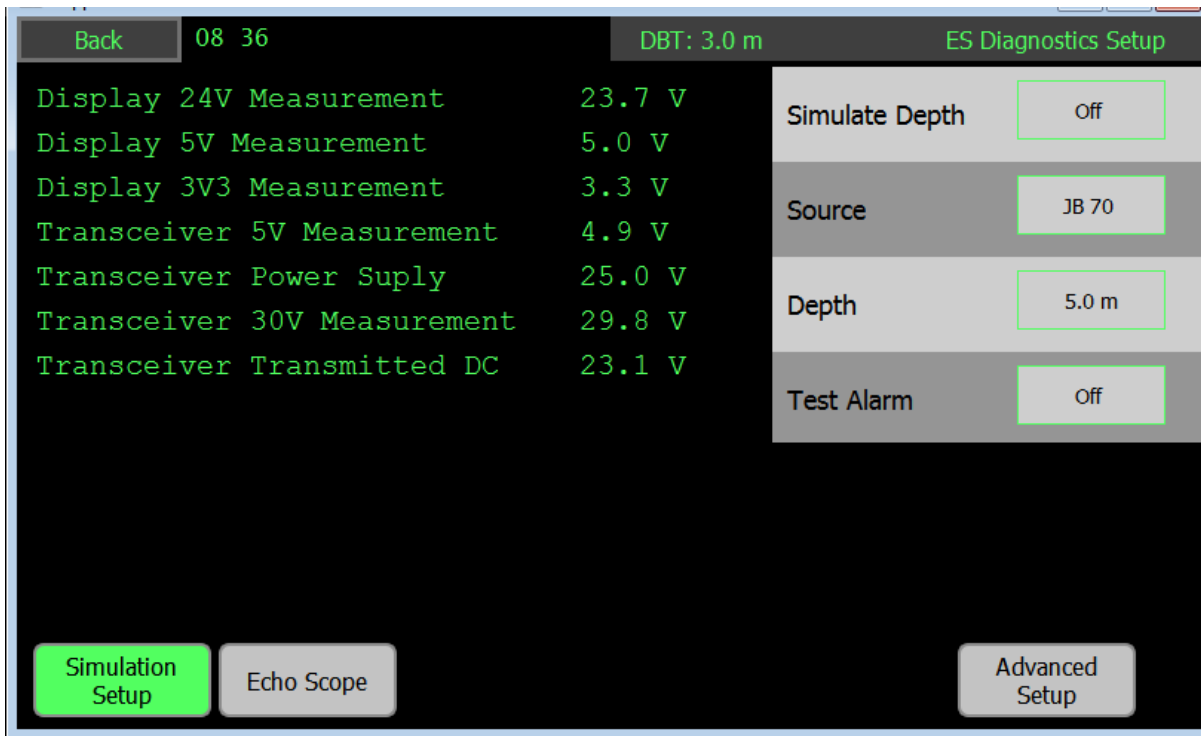

The ESN100 has a number of functions to allow the user to simulate, diagnose and optimise the system.

The Diagnostics setup will help identify the problem.

Parameter	Description
Simulate depth	Make a depth of the desired value (Depth button) To test outputs and alarms, alternatively have a moving depth , or run a simulation from file.
Depth	The value to be sent, or the value the moving depth will move above and below.
Test alarm	Send all known alarms to the output. (These can be acknowledged/ silenced/ changed as a normal alarm/alert)
Noise self test	Run this to check the Noise levels of the system
SNR Calibration	Run this calibration to tune the system once installed in the vessel
Show Noise results	Show the results of the noise test (See below)

Noise self test will run a series of pings and measurement within the system to find the noise conditions. These can be inspected by pressing the show noise button



The values shown should be below 20mV once installed unless otherwise stated. High values can usually be reduced by improved cabling and / or filters on the power supply.

Once installed, the mounting of the system can cause some changes from the default setup. This can have an effect on the auto functions. To improve this the SNR calibration can be performed and the system will optimise itself.

Each ping is plotted in the Scope screen

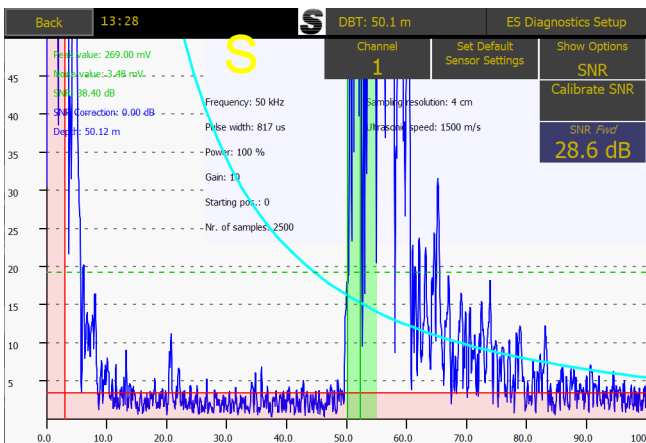

Here you can see the pings and the parameters in use to detect it, The green zone is showing the detected depth, the red zones are areas where the bottom detection will not have an effect. this is typically at low signal levels and in the ringing period after the system sends a pulse.

### Transceiver unit JB50E1-SA Diagnostics

There are 5 LEDs on the PCB giving the status of the transceiver unit



- LED1: Power ON
- LED2: Communication transmit to display
- LED3: Communication receive from display
- LED4: Ping indication
- LED5: FPGA OK

## Diagnostics of the ESN100 using an ETT985

The ETT985 echosounder and transducer tester has been updated with tests for the ESN100 echosounder and the new transducers ETS50200 and Furuno 8B-200B. These updates can be downloaded from the skipper website when the ETT software is started.

Connecting the ETT985 to the transducer ports of the JB50E1-SA unit and then running the ESN100 noise test for the appropriate frequency will allow the user or service technician to check the signal output and noise characteristics of the system.

Using the transducer tester, the connected transducers can be analysed to see if their resonance impedance is as expected.

The screenshot shows the ETT985 1.76 software interface. On the left, the 'Echo Sounder Output' section displays the following parameters:

Pulse Frequnc	49.2 kHz	min	max
Pulse Vpp	1085 V	49	51
Pulse Width	1228 us	1000	1200
Pulse Period	1571 ms	1200	1400
		1400	1600

Below this, the status is 'OK'. The main area shows a scope plot titled 'Expected received signal on the Echo Sounder'. Annotations on the plot include:

- Peak value > 0.10 mV
- Noise Value < 0.04 mV
- Main signal at 300m and significantly higher than all other spikes
- All other spikes < 0.07 mV (remove ETT power)

On the right, the 'ETT Echo Parameters' section is visible, with values for Echo Frequency (50.0 kHz), Echo Vpp (0.05 mV), Bottom Width (1000 us), and Bottom Depth (300.0 m). A table below shows 'Set following values on the Echo Sounder':

Frequency [kHz]	Range [m]	Gain [%]	TVG [%]	Power [%]
50	350	12	50	100

A text box at the bottom right provides instructions: 'Connect to JB50 J1, set the system config-Essetup-transducer setup to ETN050 and auto off. Check the values above left are green, and that the config-diagnostics-scope screen is as in the picture (Noise value should be < 0.7 remove power cable from ETT). Peak value should be 0.07'.

The screenshot shows the 'Transducer Test' setup screen in ETT985 1.76. The 'Measurement Range' section is configured as follows:

Start Frequency	180 kHz
End Frequency	210 kHz
Frequency Step	0,1 kHz

The 'Select preset' dropdown menu is open, showing options: ETS50200, 8B-200B, ETN024, ETN039, ETN050, ETN200S, and ETN200. The 'Calculated' section shows the following values:

Resonant Frequency	0 kHz
0 Ohm	0 Deg
AntiRes. Frequency	0 kHz
0 Ohm	0 Deg
Q	0
Bandwidth	0 %

At the bottom, the 'Last measurement' section shows:

Frequency	0 kHz	Impedanc	0 Ohm	Phase	0 deg	Gt	0 mS	Bt	0 mS
-----------	-------	----------	-------	-------	-------	----	------	----	------







### ESN100-SB Display outline drawings

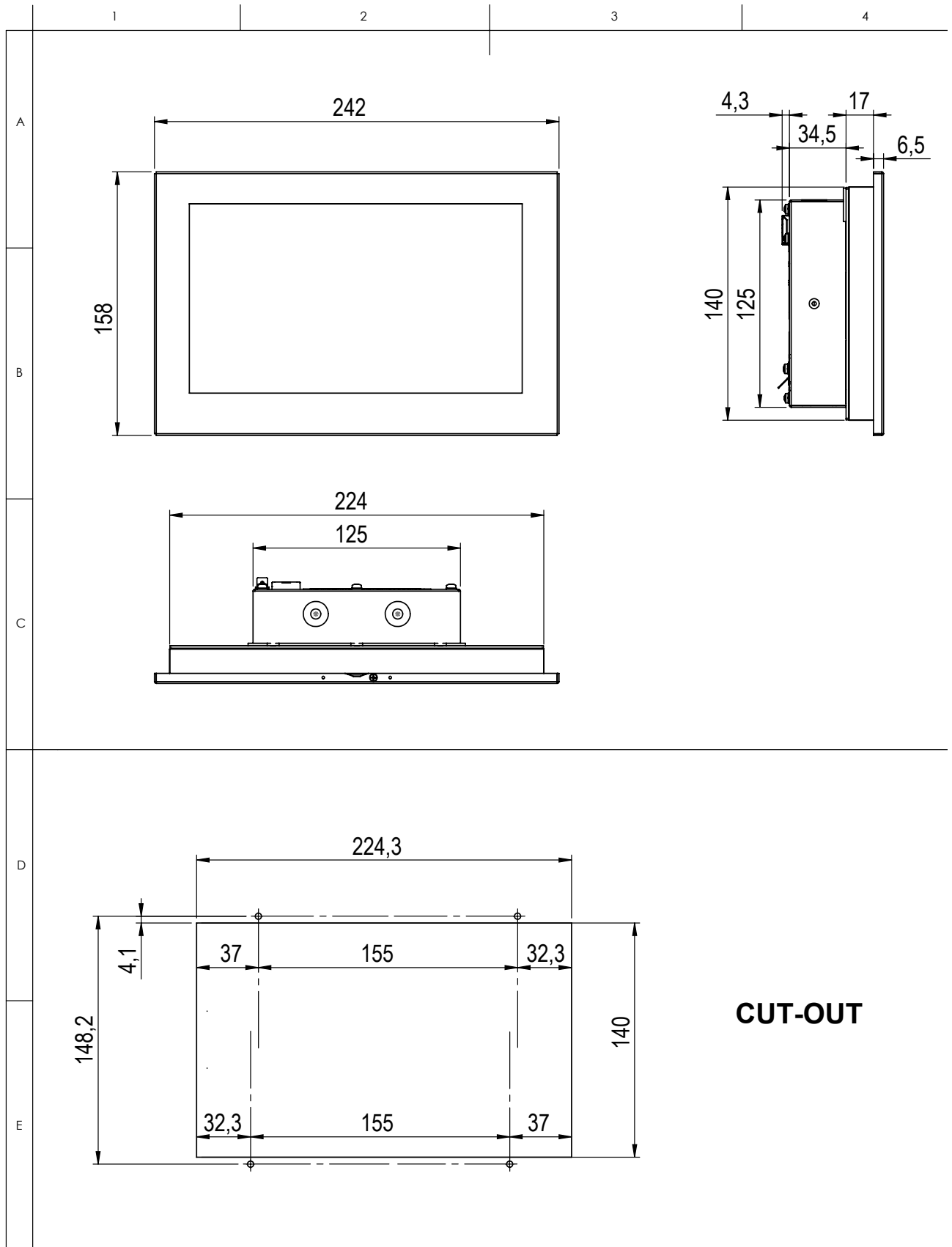

### JB50E1-SA Transceiver unit outline drawings

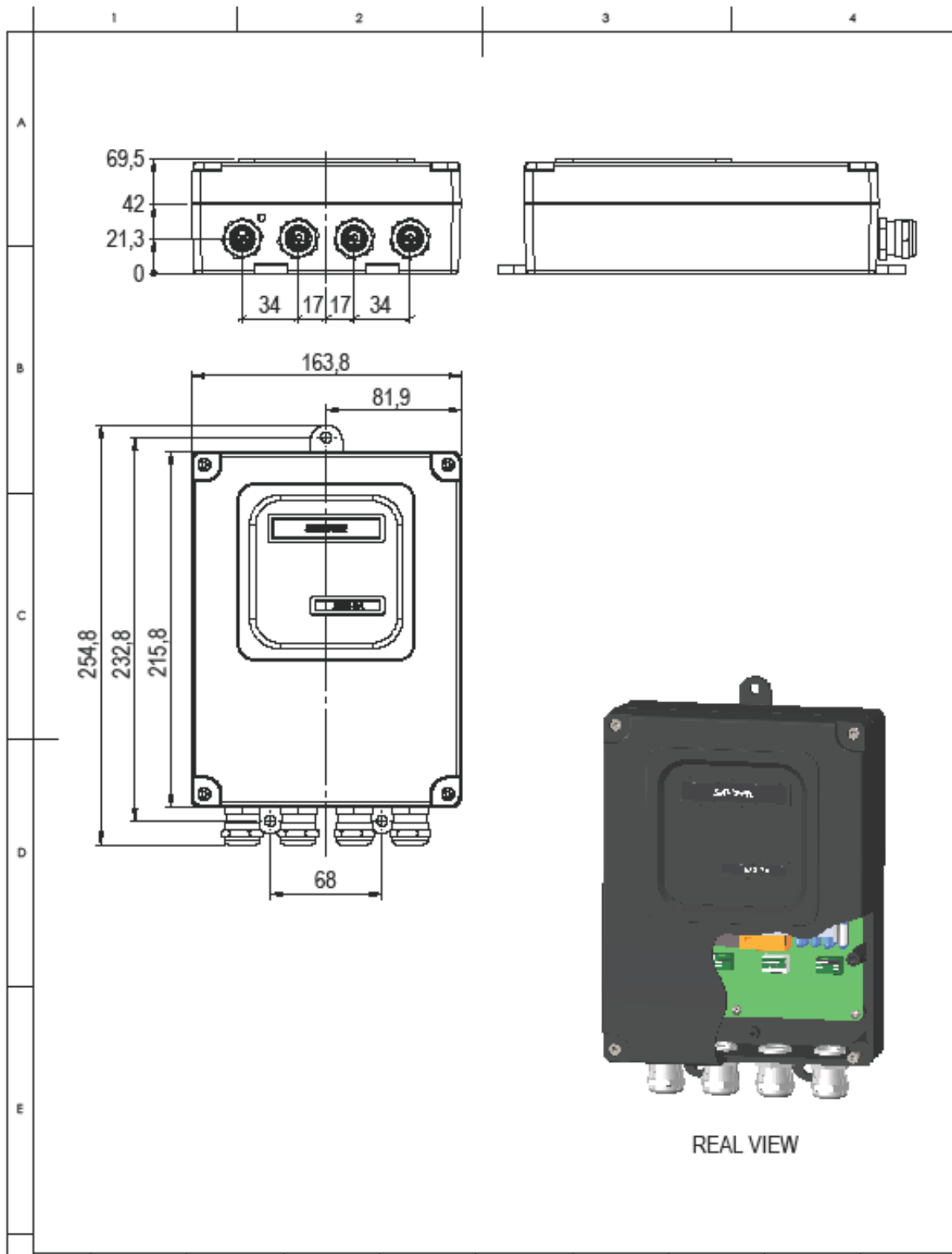

CN									
Designed by - date NILT (ST 2016.12.06)	Approved by - date PC 2016.12.06	<i>All sharp edges to be broke or deburred</i>		Material N/A					
				Name Transceiver unit ESN100					
				Drwg. no. JB50E1-ZA				Revision 01	
				Gen. tolerance ISO2768m		Eut. projection		Scale 1 : 3	Edition date 2016.12.06

## ENS518-SA Transducer selector

The ESN100 has two transducer terminals selectable from software. A transducer selector switch can be installed if more than two transducers are required.

The transducer selector switch will only be able to select between two transducers of same type and frequency

There are no selector feedback to ESN100 for indication of for/aft transducer is selected.

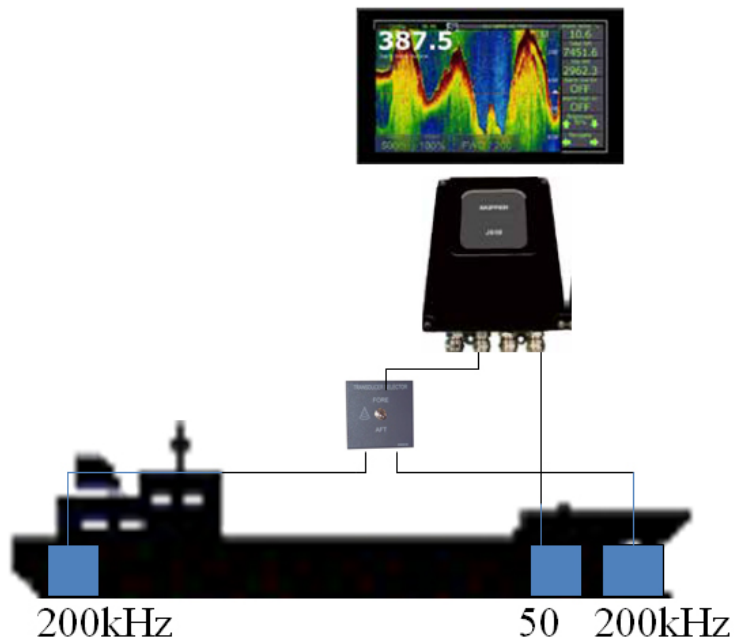

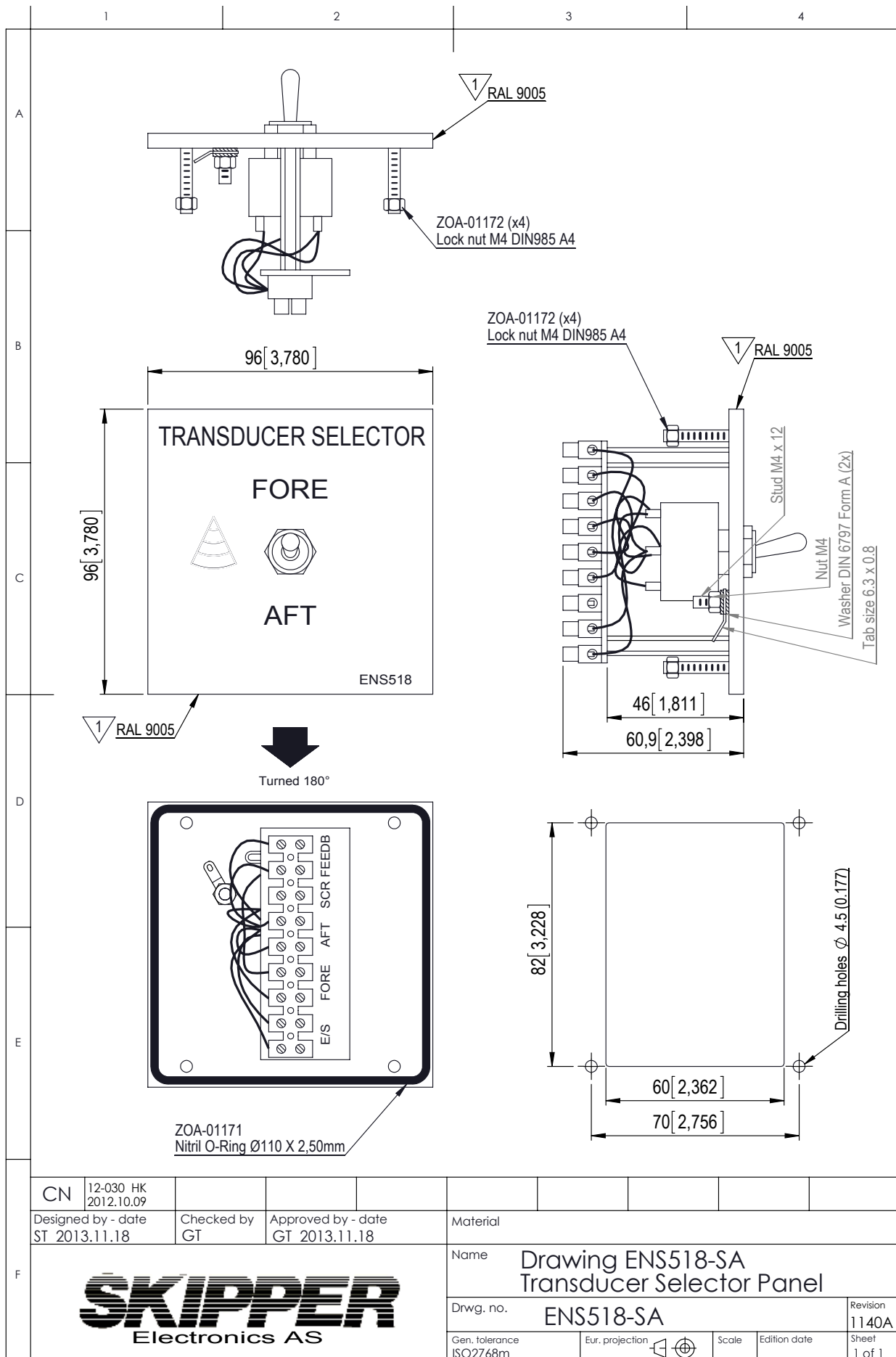

CN	12-030 HK 2012.10.09										
Designed by - date	ST 2013.11.18	Checked by	GT	Approved by - date	GT 2013.11.18	Material					
F						Name Drawing ENS518-SA Transducer Selector Panel					
						Drwg. no. ENS518-SA			Revision 1140A		
						Gen. tolerance ISO2768m		Eur. projection	Scale	Edition date	Sheet 1 of 1